

EN

NL

FR

DE

PL

CZ

IT

SK

ES

PT

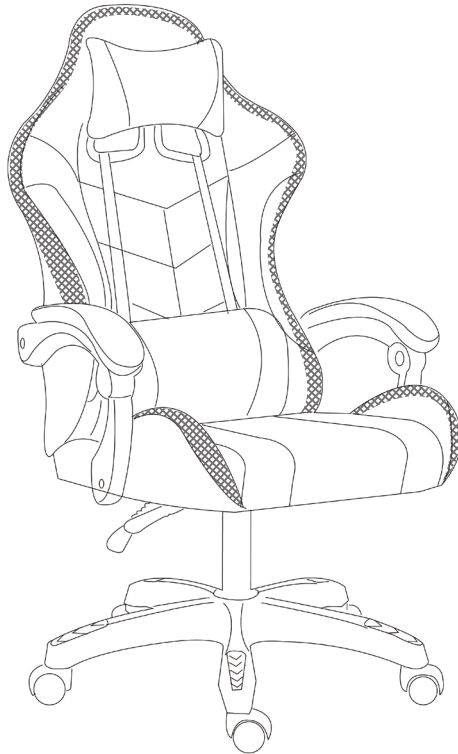

Instruction manual · Gebruiksaanwijzing  
Manuel d'instructions · Gebrauchsanweisung  
Podręcznik użytkownika · Návod k obsluze  
Manuale di istruzioni · Príručka k zariadeniu  
Manual de instrucciones · Manual de instruções

# Gaming Chair with LED

## INTRODUCTION

To get the most out of your new product, please read this manual before use. Please also save the manual in case you need to refer to it at a later date.

## TECHNICAL DATA

Size: 63x51x116-126 cm

Adjustable seat height: 42,5-52,5 cm

Adjustable back angle: 90°-135°

With RGB LED light

Power supply: USB A cable 5V 2A

Cable length: 160 cm

With RF remote control incl CR2025 battery

Transmission frequency: 433.92Mhz

Transmission power: -15,1 dBm

Max RF output power (e.i.r.p): 2,19 dBm

Max. user weight: 110 kg

### Use of RGB LED light

Connect the USB cable to a USB A power supply. Use the remote control to choose LED function and adjust the settings.



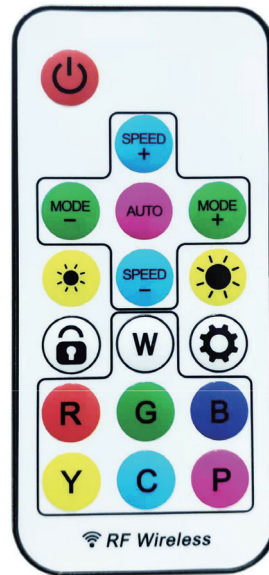













## REMOTE CONTROL



Class III product: Designed to be supplied from a separated extra low voltage supply (SELV).

The voltage from a SELV supply is low enough that a person can normally come into contact with it without the risk of electric shock.

## REMOTE CONTROL FUNCTIONS

Button	Function
	Power on/off
 , 	Adjust the speed of the LED colour change
 , 	Use the mode +/- buttons to choose the LED mode (multiple modes to choose from)
 , 	Adjust the brightness of the LEDs
	<p>Press once to auto play multiple kinds of effects. Long press 5 seconds to enter the colourfull RGB jump effect and start the LED strip test.</p> <p>Single cycle: In automatic playback mode, press the "SET" button once, then press the "lock" button to capture the current effect loop. To "unlock" the selected mode, press "auto" button or "mode" button.</p>
	To adjust the number of LED pixel points and the RGB order: Long press 5 seconds to enter the setup menu and press "MODE +" and "MODE -" to adjust the number of LED pixel points. It adjusts 32 points each time. Press "SET" to save the settings.
	Remote control ID matching: Long press 5 seconds to match remote control to the chair. (LED strip will flash green 3 times), long press again 5 seconds to cancel the match (LED strip will flash white 3 times)
	White static monochrome mode
	Red static monochrome mode
	Green static monochrome mode
	Blue static monochrome mode
	Yellow static monochrome mode
	Cyan static monochrome mode
	Purple static monochrome mode

## PARTS

a	Back
b	Seat
c	Mechanism
e	Headrest
g	Caster x 5
h	Back Bar
i	Armrest x 2
j	Base
k	Lumbar Pillow
l	Gas Lift
m	Bolt x 3
o	Wrench
p	USB A Cable
t	End cap x 4
w	End cap x 2
x	Bolt x 4
z	Bolt x 4

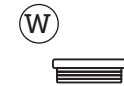
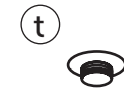
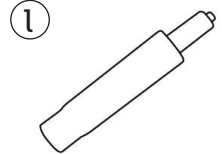
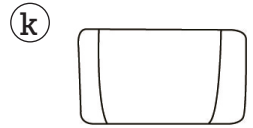
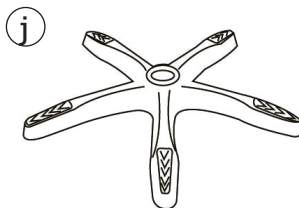
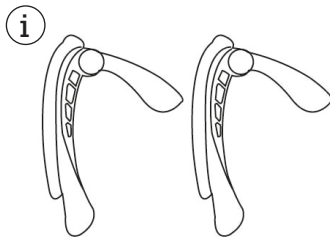
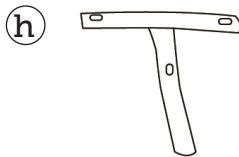
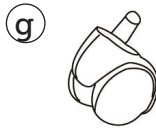
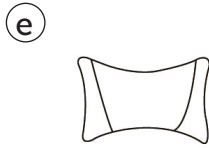
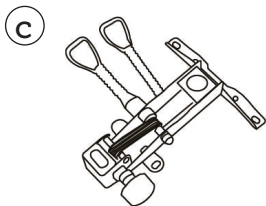
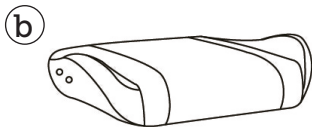
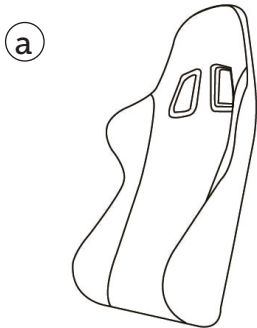

# ASSEMBLY

EN

1

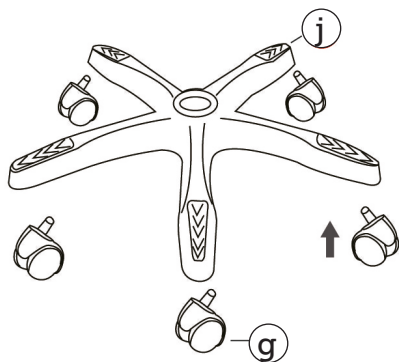

2

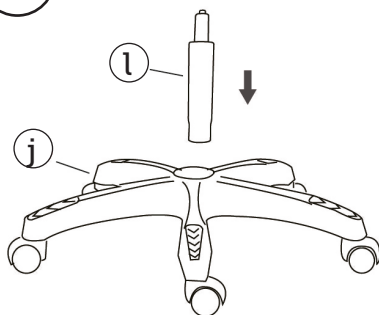

3

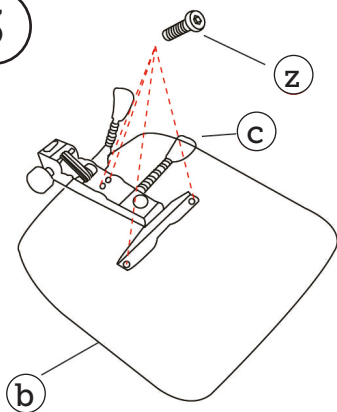

4

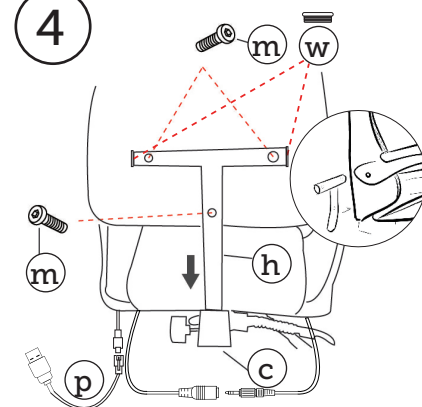

5

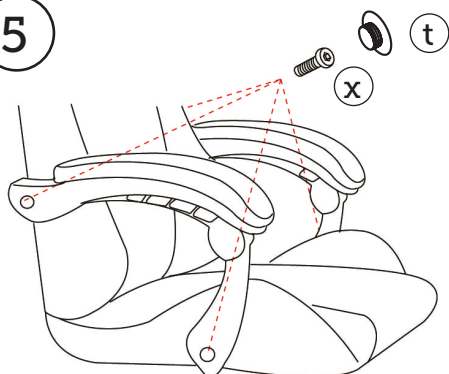

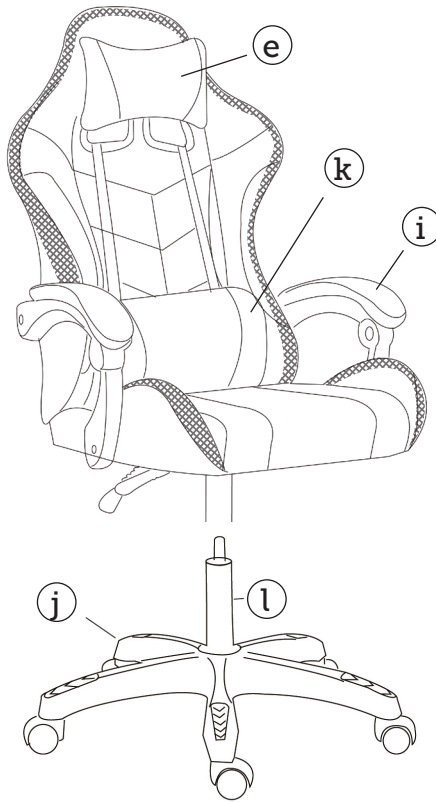

### **CLEANING AND MAINTENANCE**

Clean with a hard-wrung cloth.

Warning: This product is made of PU leather and must not be treated with leather care products, since they will destroy the PU leather.

## ENVIRONMENTAL INFORMATION



The crossed out wheeled bin symbol means that this product shall not be disposed of with normal household waste. Electronic and Electrical Equipment not included in the selective sorting process are potentially dangerous for the environment and human health due to the presence of hazardous substances. Please dispose of responsibly at an approved waste or recycling facility.

## EU DECLARATION OF CONFORMITY

[http://imagebank.schou.com/MediaLibrary?search=82066\\_DOC](http://imagebank.schou.com/MediaLibrary?search=82066_DOC)



---

## SERVICE CENTRE

Note: Please provide the product model number in connection with all inquiries. The model number is shown on the front of this manual and on the product rating plate.

[www.schou.com](http://www.schou.com)

---

Manufactured in China  
 Manufacturer:  
 Schou Company A/S  
 Nordager 31  
 DK-6000 Kolding

All rights reserved. The content of this manual may not be reproduced, either in full or in part, in any way by electronic or mechanical means, e.g. photocopying or publication, translated or saved in an information storage and retrieval system without written permission from Schou Company A/S.

---

# Gamingstoel met led

## INLEIDING

Om het beste uit uw nieuwe product te halen, gelieve deze instructies voor gebruik door te lezen. Bewaar de handleiding voor het geval u deze op een later moment wilt raadplegen.

## TECHNISCHE GEGEVENS

Afmetingen: 63x51x116-126 cm

Verstelbare zithoogte: 42,5-52,5 cm

Verstelbare rughoek: 90°-135°

Met RGB-ledlicht

Voeding: USB A-kabel 5 V 2 A

Snoerlengte: 160 cm

Met radiografische afstandsbediening  
incl. CR2025 batterij

Zendfrequentie: 433,92 MHz

Zendvermogen: -15,1 dBm

Maximaal RF-uitgangsvermogen  
(e.i.r.p.): 2,19 dBm

Max. gebruikersgewicht: 110 kg

### Gebruik van RGB-ledlicht

Sluit de USB-kabel aan op een USB A-voeding. Gebruik de afstandsbediening om de ledfunctie te kiezen en de instellingen aan te passen.





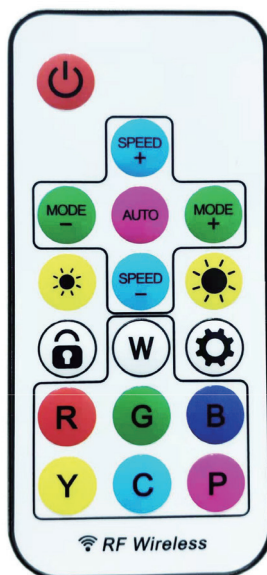











 Klasse III-product: Ontworpen om te worden gevoed door een afzonderlijke veilige laagspanningsbron (SELV). De spanning van een afzonderlijke SELV-bron is laag genoeg dat deze geen gevaar oplevert voor personen wanneer de huid ermee in contact komt.

## AFSTANDSBEDIENING





## AFSTANDSBEDIENINGSFUNCTIES

Knop	Funcities
	Voeding aan/uit
 , 	Pas de snelheid van de ledkleurverandering aan
 , 	Gebruik de modusknoppen "mode -/+ " om de ledmodus te kiezen (meerdere modi om uit te kiezen)
 , 	Pas de helderheid van de leds aan
	Druk eenmaal om meerdere soorten effecten automatisch af te spelen. 5 seconden lang indrukken om het kleurige RGB-jump-effect in te voeren en de ledstrip test te starten.  Enkele cyclus: Druk in de automatische afspeelmodus eenmaal op de knop "SET" en vervolgens op de knop met het hangslot om de huidige effectlus vast te leggen. Om de geselecteerde modus te "ontgrendelen", moet u op de knop "auto" of "mode" drukken.
	Doe het volgende om het aantal leds en de kleurvolgorde aan te passen: Houd de knop 5 seconden lang ingedrukt om het instelmenu te openen en druk op "MODE +" en "MODE -" om het aantal ledpixelpunten aan te passen. Hiermee past u telkens 32 punten aan. Druk op "SET" om de instellingen op te slaan.
	ID-matching afstandsbediening: Houd de knop 5 seconden lang ingedrukt om de afstandsbediening aan de stoel te koppelen. De ledstrip knippert 3 keer groen. Houd de knop 5 seconden lang ingedrukt om de match te annuleren. De ledstrip knippert 3 keer wit.
	Witte statische monochrome modus
	Rode statische monochrome modus
	Groene statische monochrome modus
	Blauwe statische monochrome modus
	Gele statische monochrome modus
	Cyaankleurige statische monochrome modus
	Paarse statische monochrome modus

## ONDERDELEN

a	Rug
b	Zitting
c	Mechanisme
e	Hoofdsteen
g	Zwenkwiel 5x
h	Rugstang
i	Armleuning 2x
j	Voet
k	Lendenkussen
l	Gasveer
m	Bout 3x
o	Steeksleutel
p	USB A-kabel
t	Eindkap 4x
w	Eindkap 2x
x	Bout 4x
z	Bout 4x

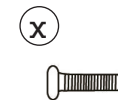
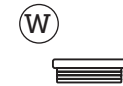
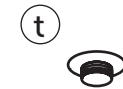
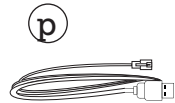
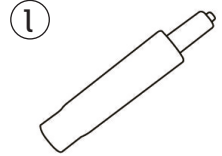
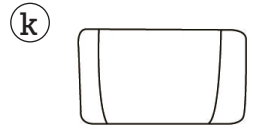
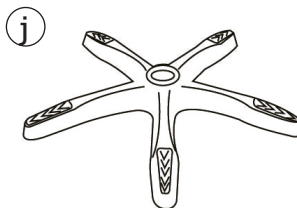
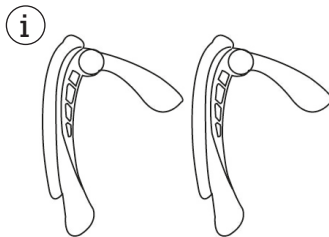
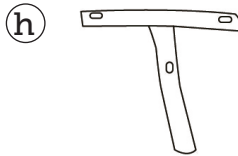
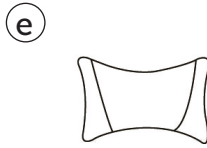
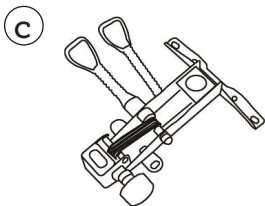
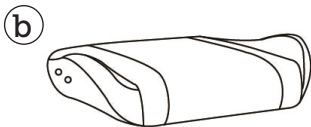
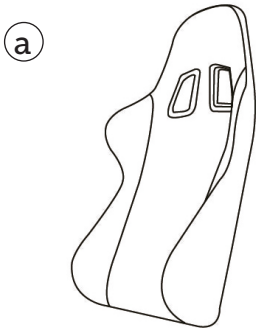

# MONTAGE

NL

1

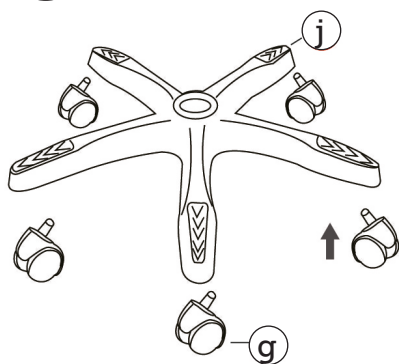

2

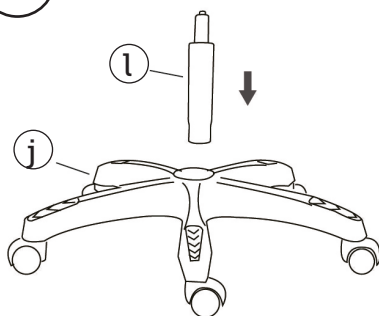

3

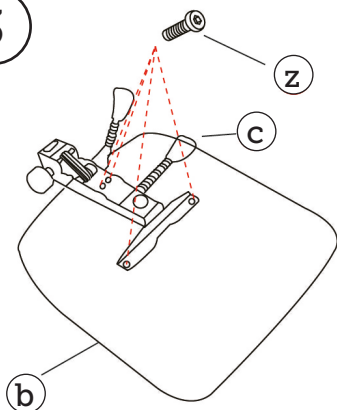

4

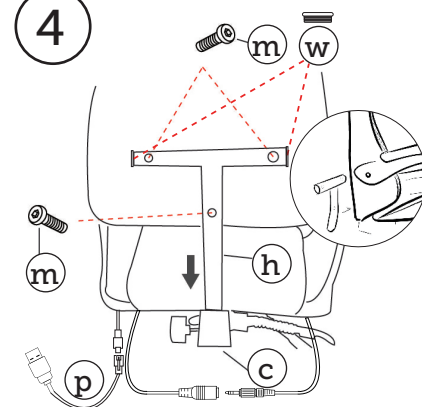

5

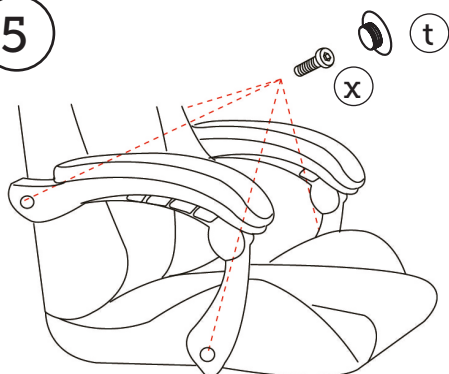

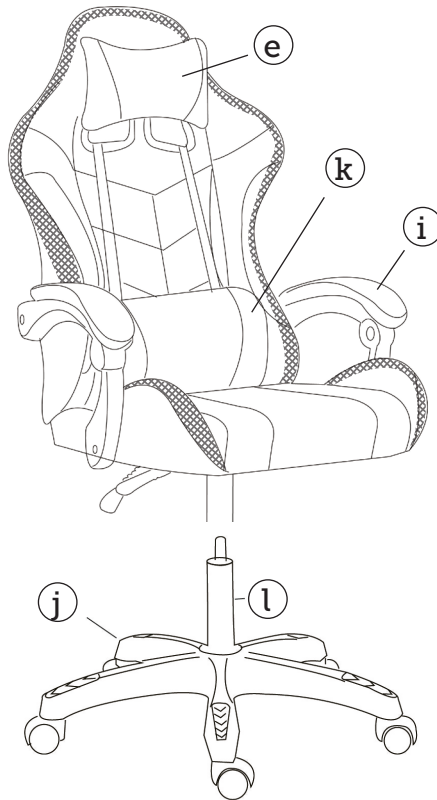

## **REINIGEN EN ONDERHOUDEN**

Schoonmaken met een uitgewrongen doek.

Waarschuwing: Dit product is gemaakt van PU-leer en mag niet worden behandeld met lederverzorgingsproducten omdat die het PU-leer aantasten.

## MILIEU-INFORMATIE



Het symbool van de doorgesleutelde vuilnisbak betekent dat dit product niet met het normale huishoudelijke afval mag worden weggegooid. Elektronische en elektrische apparatuur die niet in het selectieve sorteerproces is opgenomen, is wegens de aanwezigheid van gevaarlijke stoffen potentieel gevaarlijk voor het milieu en de menselijke gezondheid. Gelieve deze op verantwoorde wijze af te voeren naar een erkende afvalverwerkings- of recyclinginstallatie.

## EU-CONFORMITEITSVERKLARING

[http://imagebank.schou.com/MediaLibrary?search=82066\\_DOC](http://imagebank.schou.com/MediaLibrary?search=82066_DOC)



---

## SERVICE CENTRE

Let op: Vermeld bij alle vragen het productmodelnummer. Het modelnummer staat op de voorkant van deze handleiding en op het product-typeplaatje.

[www.schou.com](http://www.schou.com)

---

Vervaardigd in P.R.C.

Fabrikant:

Schou Company A/S  
Nordager 31  
DK-6000 Kolding

Alle rechten voorbehouden. De inhoud van deze handleiding mag op geen enkele wijze, noch volledig noch in delen, elektronisch of mechanisch gereproduceerd worden, bijv. kopiëren of publicatie, vertaald of opgeslagen in een informatie-opslag- en ontsluitingssysteem zonder schriftelijke toestemming van Schou Company A/S.

---

# Chaise gaming avec LED

## INTRODUCTION

Pour profiter au mieux de toutes les possibilités offertes par votre nouveau produit, veuillez lire entièrement les instructions avant toute utilisation. Veuillez également conserver ces instructions au cas où vous auriez besoin de les consulter ultérieurement.

## CARACTÉRISTIQUES TECHNIQUES

Dimensions : 63 x 51 x 116 - 126 cm

Hauteur d'assise réglable :  
42,5 - 52,5 cm

Inclinaison du dossier réglable :  
90°-135°

Avec lumières DEL RGB

Alimentation électrique :  
USB A câble 5 V 2 A

Longueur du câble : 160 cm

Avec télécommande RF, pile CR2025  
incluse

Fréquence de transmission :  
433,92 MHz

Puissance de transmission : -15,1 dBm

Puissance de sortie FR max. : 2,19 dBm

Poids max. de l'utilisateur : 110 kg

### Utilisation de la lumière DEL RGB

Connectez le câble USB à une alimentation USB A. Utilisez la télécommande pour choisir la fonction DEL et régler les paramètres.





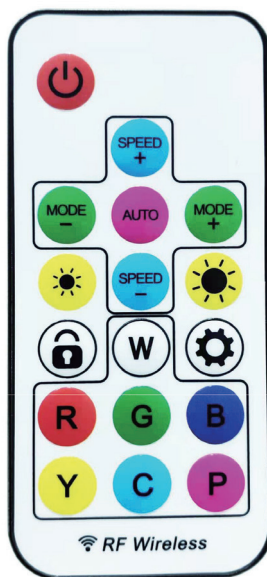











 Produit de classe III : Conçu pour être raccordé à une alimentation à très basse tension de sécurité (SELV). La tension d'une alimentation à très basse tension de sécurité (SELV) est suffisamment faible pour qu'une personne puisse y être exposée sans risque de choc électrique.

## TÉLÉCOMMANDE



## FONCTIONS DE LA TÉLÉCOMMANDE

FR

Bouton	Fonction
	Marche/arrêt
 , 	Régler la vitesse de changement de couleur de la DEL
 , 	Utilisez les boutons -/+ pour choisir le mode de la DEL (plusieurs modes possibles)
 , 	Régler la luminosité des DEL
	Appuyez une fois pour jouer automatiquement plusieurs types d'effets. Appuyez longuement pendant 5 secondes pour lancer l'effet de changement RVB coloré et effectuer le test de la bande DEL.  Cycle unique : En mode de lecture automatique, appuyez une fois sur le bouton « SET », puis sur le bouton « cadenas » pour capturer la boucle d'effet en cours. Pour déverrouiller le mode sélectionné, appuyez sur le bouton « AUTO » ou le bouton « MODE ».
	Pour régler le nombre de points de pixels de la DEL et l'ordre RVB : Appuyez longuement pendant 5 secondes pour entrer dans le menu de configuration et appuyez sur « MODE + » et « MODE - » pour régler le nombre de points de pixels de la DEL. 32 points sont ajustés à chaque fois. Appuyez sur « SET » pour enregistrer les paramètres.
	Correspondance de l'identification de la télécommande : Appuyez longuement pendant 5 secondes pour faire correspondre la télécommande à la chaise (la bande DEL clignote 3 fois en vert). Appuyez longuement pendant 5 secondes pour annuler la correspondance (la bande DEL clignote 3 fois en blanc).
	Mode monochrome statique blanc
	Mode monochrome statique rouge
	Mode monochrome statique vert
	Mode monochrome statique bleu
	Mode monochrome statique jaune
	Mode monochrome statique cyan
	Mode monochrome statique violet

## PIÈCES

a	Arrière
b	Siège
c	Mécanisme
e	Appuie-tête
g	Roulettes x 5
h	Barre arrière
i	Accoudoir x 2
j	Base
k	Soutien lombaire
l	Vérin pneumatique
m	Boulon x 3
o	Clé
p	Câble USB A
t	Capuchon d'extré- mité x 4
w	Capuchon d'extré- mité x 2
x	Boulon x 4
z	Boulon x 4

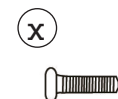
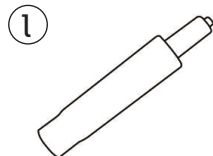
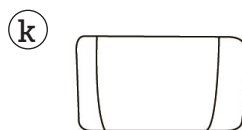
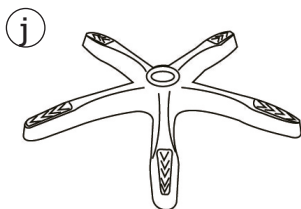
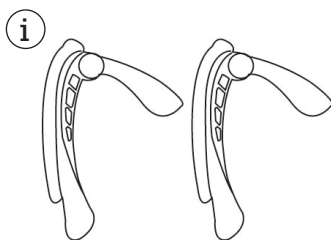
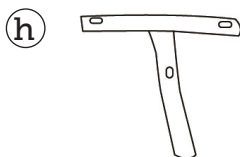
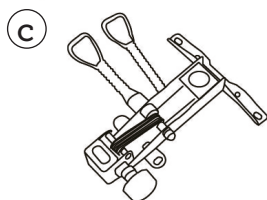
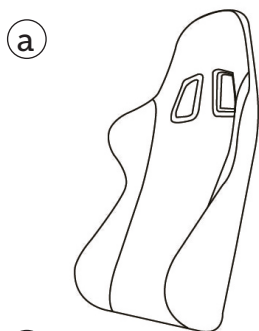



# MONTAGE

1

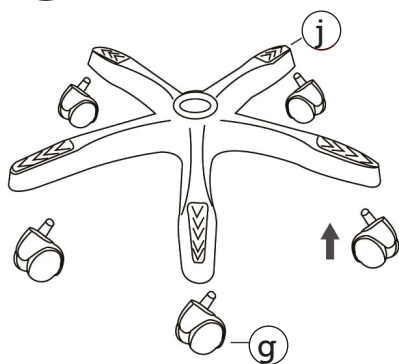

2

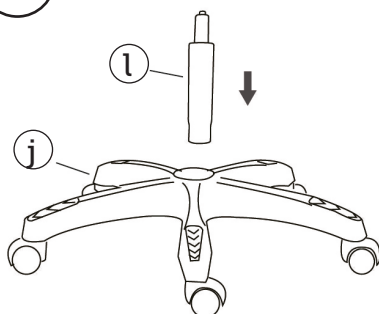

FR

3

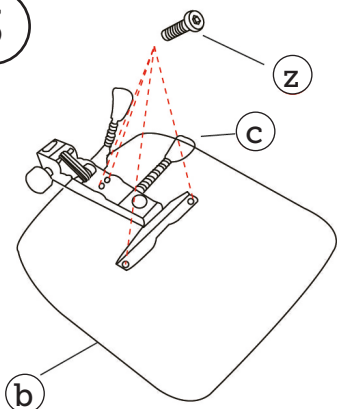

4

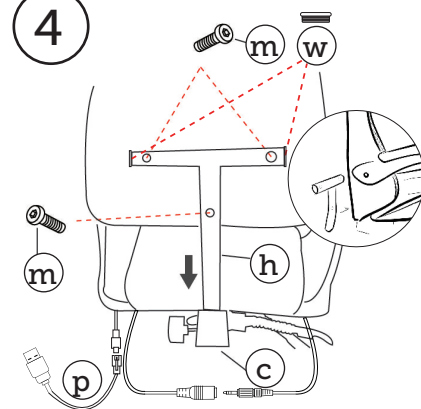

5

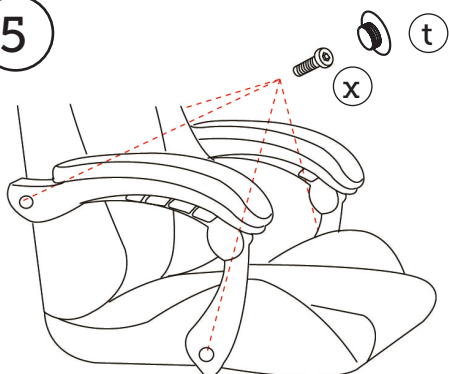

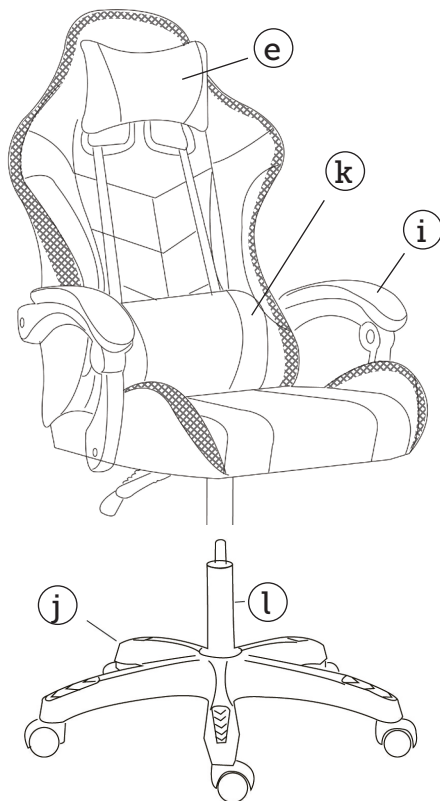

### **NETTOYAGE ET ENTRETIEN**

Nettoyer avec un chiffon bien essoré.

Attention : Ce produit est fabriqué en cuir PU et ne doit pas être traité avec des produits d'entretien du cuir, car ils détruiraient le cuir PU.

## INFORMATIONS RELATIVES À L'ENVIRONNEMENT



Le symbole de la poubelle barrée signifie que ce produit ne doit pas être jeté avec les ordures ménagères courantes. Les équipements électroniques et électriques non intégrés au processus de tri sélectif sont potentiellement dangereux pour l'environnement et la santé humaine en raison de la présence de substances dangereuses. Veuillez les mettre au rebut de manière responsable dans un centre de recyclage ou de traitement des déchets agréé.

## DÉCLARATION UE DE CONFORMITÉ

[http://imagebank.schou.com/MediaLibrary?search=82066\\_DOC](http://imagebank.schou.com/MediaLibrary?search=82066_DOC)



---

## CENTRE DE SERVICE

Remarque : veuillez toujours mentionner le numéro de modèle du produit en cas de demande.

Le numéro de modèle est indiqué sur la première page de ce manuel et sur la plaque signalétique du produit.

[www.schou.com](http://www.schou.com)

---

Fabriqué en R.P.C.

Fabricant :

Schou Company A/S  
Nordager 31  
DK-6000 Kolding

Tous droits réservés. Le contenu du présent manuel ne doit en aucun cas être reproduit intégralement ou partiellement, sous forme électronique ou mécanique (par exemple par photocopie ou numérisation), traduit ou sauvegardé dans un système de stockage et de récupération d'informations sans l'accord écrit de Schou Company A/S.

---

# Gaming-Stuhl mit LED

## EINFÜHRUNG

Damit Sie an Ihrem neuen Produkt möglichst lange Freude haben, bitten wir Sie, die Gebrauchsanweisung und die beiliegenden Sicherheitshinweise vor Ingebrauchnahme sorgfältig durchzulesen.

Ferner wird empfohlen, die Gebrauchsanweisung für den Fall aufzubewahren, dass Sie sich die Funktionen des Produkts später nochmals ins Gedächtnis rufen möchten.

## TECHNISCHE DATEN

Abmessungen: 63 × 51 × 116–126 cm

Einstellbare Sitzhöhe: 42,5–52,5 cm

Einstellbarer Rückenwinkel: 90°–135°

Mit RGB-LED-Beleuchtung

Stromversorgung: USB-A-Kabel, 5 V, 2 A

Kabellänge: 160 cm

Mit Fernbedienung einschließlich CR2025-Batterie

Übertragungsfrequenz: 433,92 MHz

Sendeleistung: -15,1 dBm

Maximale Funksendeleistung (äquivalente isotrope Strahlungsleistung): 2,19 dBm

Max. Benutzergewicht: 110 kg

## Verwendung der RGB-LED-Beleuchtung

Schließen Sie das USB-Kabel an ein USB-A-Netzteil an. Wählen Sie mithilfe der Fernbedienung die LED-Funktion aus und passen Sie die Einstellungen an.







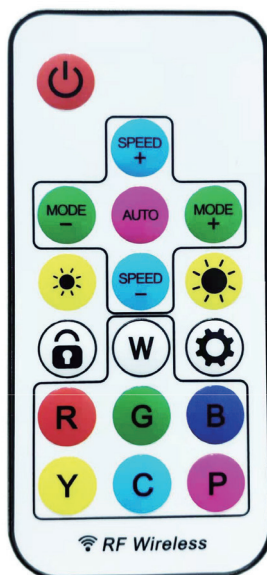









Produkt der Klasse III: Vorgesehen zur Nutzung mit getrennter Kleinspannungsversorgung. Die Spannung einer Kleinspannungsversorgung ist so niedrig, dass eine Person im Normalfall ohne Stromschlaggefahr mit ihr in Berührung kommen kann.

## FERNBEDIENUNG



## FUNKTIONEN DER FERNBEDIENUNG

DE

Taste	Funktion
	Ein- und ausschalten
	Einstellen der Geschwindigkeit des LED-Farbwechsels
	Die Tasten „-“ und „+“ dienen zur Wahl des LED-Modus. Es stehen mehrere Modi zur Auswahl.
	Einstellen der Helligkeit der LEDs
	Drücken Sie einmal, um mehrere Effektarten automatisch durchzuspielen. Drücken Sie fünf Sekunden lang, um den bunten RGB-Sprungeffekt zu aktivieren und den LED-Streifentest zu starten.  Einzelzyklus: Drücken Sie im automatischen Wiedergabemodus einmal die Einstell-Taste (Zahnrad) und dann die Sperr-Taste (Schloss), um die aktuelle Effektschleife festzuhalten. Um den gewählten Modus zu „entsperren“, drücken Sie die Taste „AUTO“ oder „MODE“.
	Einstellen der Anzahl der LED-Pixelpunkte und der RGB-Reihenfolge: Drücken Sie fünf Sekunden lang, um das Einstell-Menü aufzurufen. Stellen Sie die Anzahl der LED-Pixelpunkte dann mit den Tasten „MODE +“ und „MODE -“ ein. Es werden jedes Mal 32 Punkte angepasst. Drücken Sie die Einstell-Taste (Zahnrad), um die Einstellungen zu speichern.
	Koppelung der Fernbedienungs-ID: Drücken Sie fünf Sekunden lang, um die Fernbedienung mit dem Stuhl zu koppeln. (LED-Streifen blinkt dreimal grün). Drücken Sie fünf Sekunden lang zum Entkoppeln (LED-Streifen blinkt dreimal weiß).
	Modus: unbewegt, einfarbig weiß
	Modus: unbewegt, einfarbig rot
	Modus: unbewegt, einfarbig grün
	Modus: unbewegt, einfarbig blau
	Modus: unbewegt, einfarbig gelb
	Modus: unbewegt, einfarbig cyan
	Modus: unbewegt, einfarbig lila

# TEILE

a	Rückenlehne
b	Sitzfläche
c	Mechanismus
e	Kopfstütze
g	fünf Stuhlrollen
h	Rückenstütze
i	zwei Armlehnen
j	Fußkreuz
k	Rückenkissen
l	Gasdruckfeder
m	drei Bolzen
o	Inbusschlüssel
p	USB-A-Kabel
t	vier Endkappen
w	zwei Endkappen
x	vier Bolzen
z	vier Bolzen

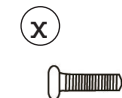
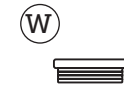
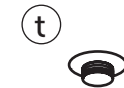
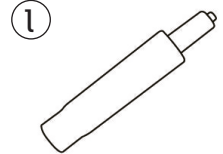
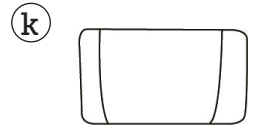
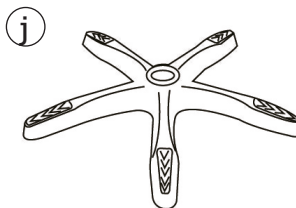
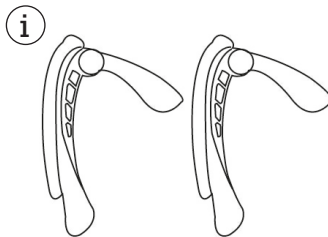
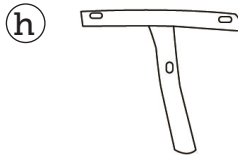
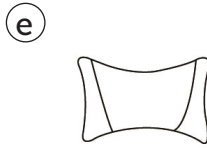
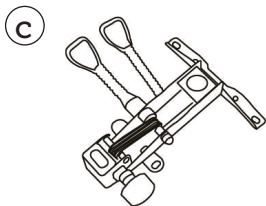
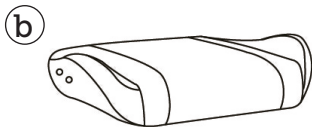
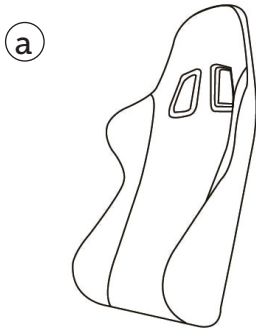

# ZUSAMMENBAU

1

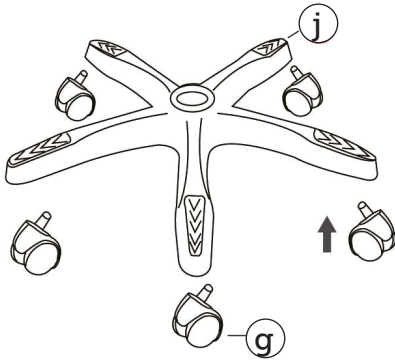

2

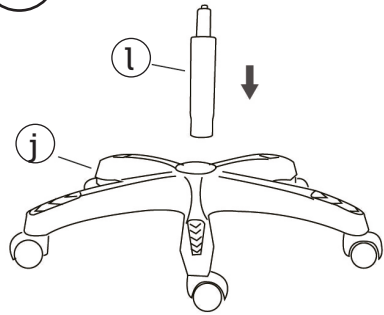

DE

3

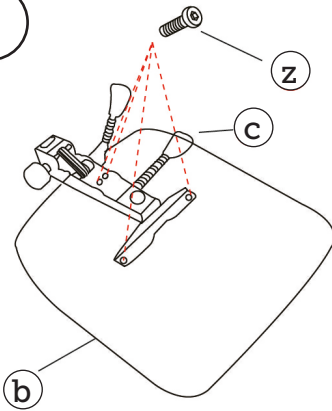

4

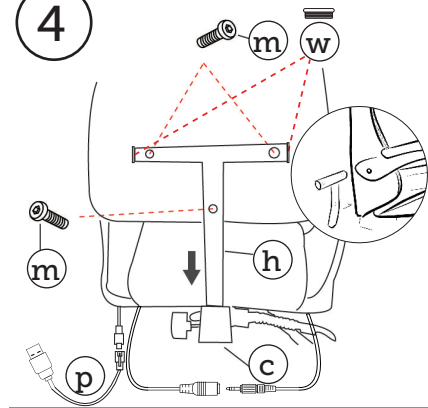

5

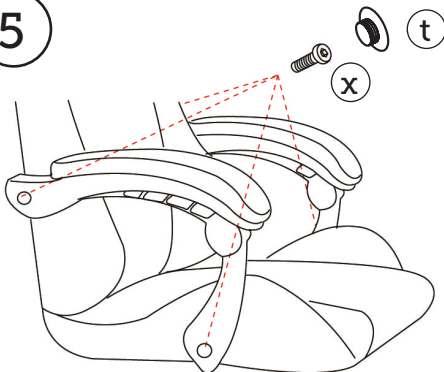

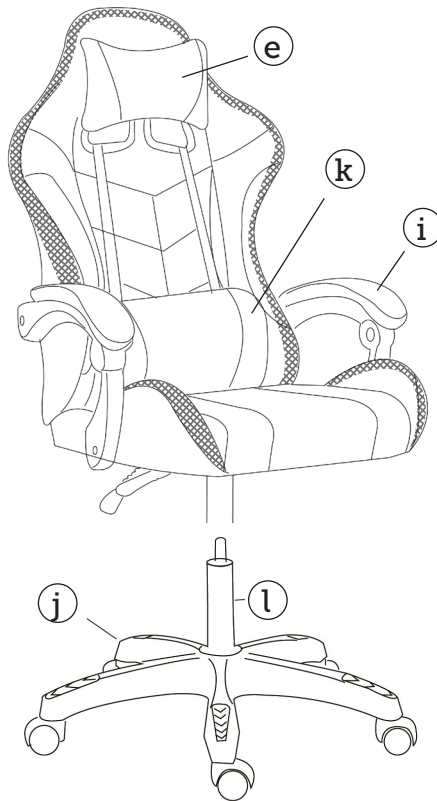

## **REINIGUNG UND PFLEGE**

Mit gut ausgewrungenem Tuch reinigen.

Warnung: Dieses Produkt ist aus PU-Leder gefertigt und darf nicht mit Lederpflegemitteln behandelt werden, da diese das PU-Leder angreifen würden.



## UMWELTINFORMATIONEN



Das Symbol der durchgestrichenen Mülltonne bedeutet, dass dieses Produkt nicht über den normalen Hausmüll entsorgt werden darf. Elektronische und elektrische Geräte, die nicht vom Mülltrennungsverfahren erfasst sind, können gefährliche Stoffe enthalten und schädlich für die Umwelt und die menschliche Gesundheit sein. Bitte entsorgen Sie solche Geräte auf verantwortungsvolle Weise in einer zugelassenen Abfall- oder Wiederverwertungsanlage.

## EU-ÜBEREINSTIMMUNGSERKLÄRUNG

[http://imagebank.schou.com/MediaLibrary?search=82066\\_DOC](http://imagebank.schou.com/MediaLibrary?search=82066_DOC)



---

## SERVICECENTER

Hinweis: Bei Anfragen stets die Modellnummer des Produkts angeben. Die Modellnummer finden Sie auf der Titelseite dieser Gebrauchsanweisung und auf dem Typenschild des Produkts.

[www.schou.com](http://www.schou.com)

---

Hergestellt in der  
Volksrepublik China

Hersteller:

Schou Company A/S  
Nordager 31  
DK-6000 Kolding

Alle Rechte vorbehalten. Der Inhalt dieser Gebrauchsanweisung darf ohne die schriftliche Genehmigung von Schou Company A/S weder ganz noch teilweise in irgendeiner Form unter Verwendung elektronischer oder mechanischer Hilfsmittel, wie zum Beispiel durch Fotokopieren oder Aufnahmen, wiedergegeben, übersetzt oder in einem Informationsspeicher und -abrufsystem gespeichert werden.

---

# Fotel dla graczy z oświetleniem LED

## WPROWADZENIE

Aby w jak największym stopniu wykorzystać zalety nowego produktu, przed rozpoczęciem korzystania należy przeczytać niniejszą instrukcję obsługi. Należy zachować ten podręcznik na wypadek konieczności odniesienia się do niego w przyszłości.

## DANE TECHNICZNE

Wymiary: 63x51x116-126 cm

Regulowana wysokość siedziska:  
42,5-52,5 cm

Regulowany kąt nachylenia oparcia:  
90°-135°

Z oświetleniem LED RGB

Zasilanie: Kabel USB A 5V 2A

Długość kabla: 160 cm

W zestawie pilot zdalnego sterowania z baterią CR2025

Częstotliwość transmisji: 433,92 MHz

Moc nadawania: -15,1 dBm

Maksymalna moc wyjściowa sygnału radiowego (e.i.r.p): 2,19 dBm

Maks. ciężar użytkownika: 110 kg

## Oświetlenie LED RGB

Podłącz kabel USB do zasilacza USB A. Użyj pilota, aby włączyć funkcję oświetlenia LED oraz dostosować ustawienia.





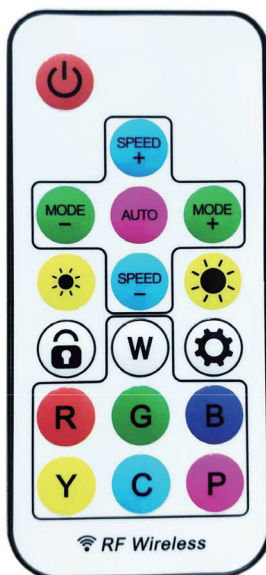











 Produkt klasy III: Przeznaczony do zasilania z oddzielnego źródła o bardzo niskim napięciu (SELV). Napięcie ze źródła SELV jest na tyle niskie, że w normalnych warunkach człowiek może się z nim zetknąć bez ryzyka porażenia.

## PILOT ZDALNEGO STEROWANIA



## FUNKCJE PILOTA

PL

Przycisk	Funkcja
	Włączanie/wyłączanie
 , 	Regulacja szybkości zmiany koloru LED
 , 	Użyj przycisków -/+, aby wybrać tryb LED (wiele trybów do wyboru)
 , 	Regulacja jasności LED
	Naciśnij raz, aby automatycznie odtwarzać wiele rodzajów efektów. Długie naciśnięcie 5 sekund powoduje wejście w kolorowy efekt RGB oraz rozpoczęcie testu oświetlenia LED.  Pojedynczy cykl: W trybie automatycznego odtwarzania naciśnij raz przycisk „SET”, a następnie naciśnij „lock”, aby zatrzymać aktualny efekt. Aby „odblokować” wybrany tryb, naciśnij przycisk „auto” lub „mode”.
	Aby dostosować liczbę punktów LED oraz kolejność RGB: Naciśnij przez 5 sekund, aby wejść do menu ustawień oraz naciśnij „MODE +” i „MODE -”, aby dostosować liczbę punktów LED. Za każdym razem dostosowuje 32 punkty. Naciśnij „SET”, aby zapisać ustawienia.
	Przypisanie identyfikatora pilota: Naciśnij przez 5 sekund, aby przypisać pilota do fotela. (pasek LED zamiga 3 razy na zielono), naciśnij ponownie przez 5 sekund, aby anulować przypisanie (pasek LED zamiga 3 razy na biało)
	Biały statyczny tryb monochromatyczny
	Czerwony statyczny tryb monochromatyczny
	Zielony statyczny tryb monochromatyczny
	Niebieski statyczny tryb monochromatyczny
	Żółty statyczny tryb monochromatyczny
	Cyjanowy statyczny tryb monochromatyczny
	Fioletowy statyczny tryb monochromatyczny

## CZĘŚCI

a	Oparcie
b	Siedzisko
c	Mechanizm
e	Zagłówek
g	Kółko x 5
h	Belka tylna
i	Podłokietnik x 2
j	Podstawa
k	Poduszka lędźwio- wa
l	Podnośnik gazowy
m	Śruba x 3
o	Klucz
p	Kabel USB A
t	Zatyczka x 4
w	Zatyczka x 2
x	Śruba x 4
z	Śruba x 4

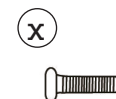
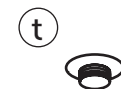
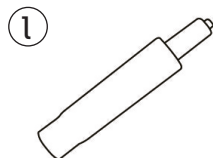
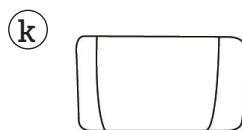
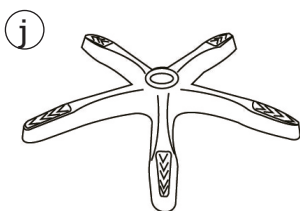
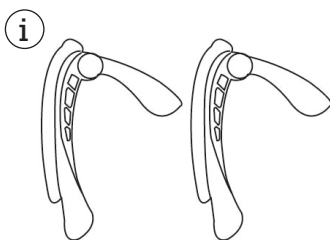
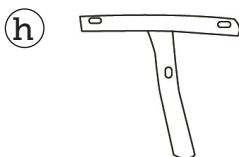
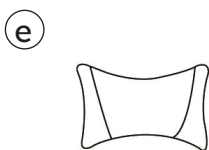
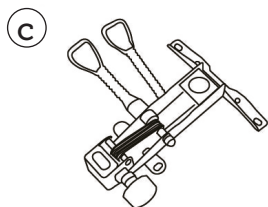
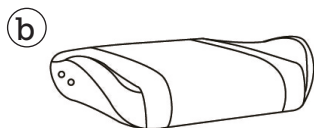
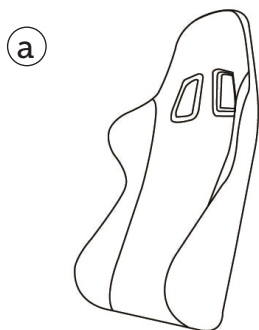

# MONTAŻ

1

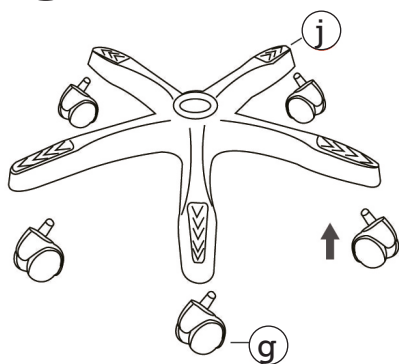

2

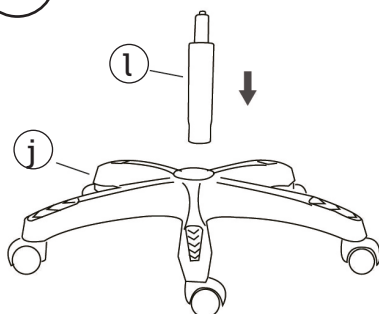

PL

3

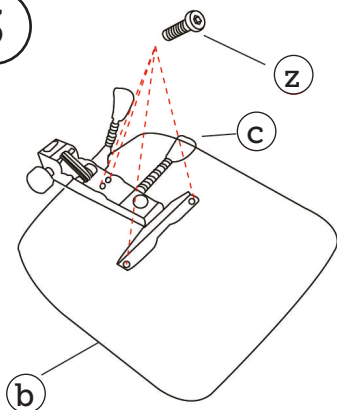

4

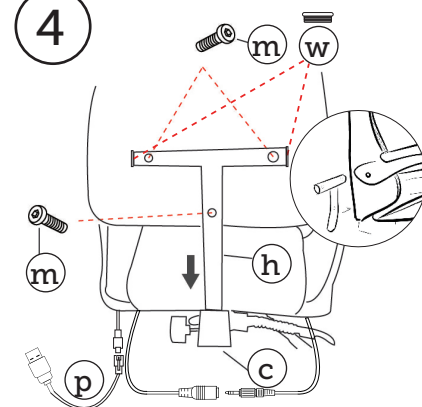

5

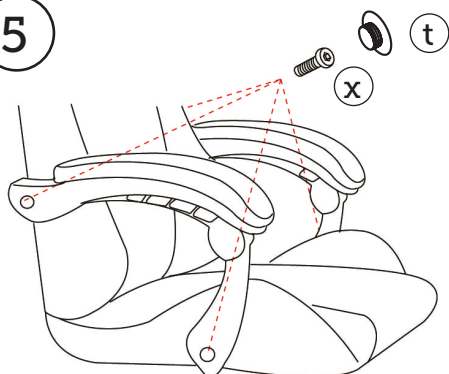

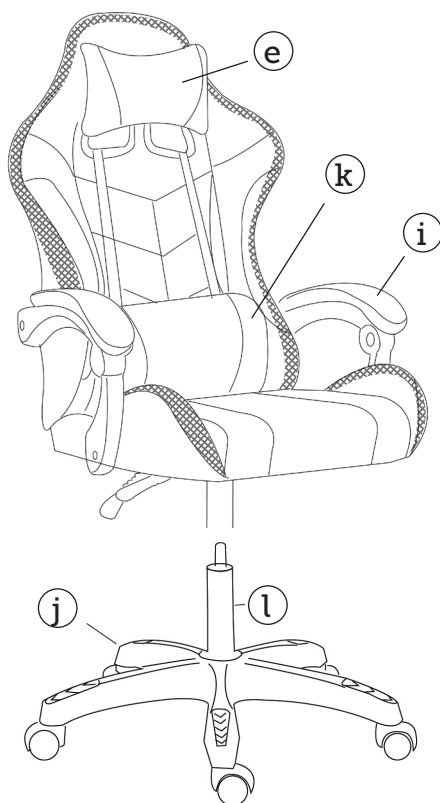

### **CZYSZCZENIE I KONSERWACJA**

Czyścić za pomocą wilgotnej ściereczki.

Ostrzeżenie: Ten produkt wykonany jest ze skóry syntetycznej oraz nie wolno go traktować środkami do pielęgnacji skóry naturalnej.

## INFORMACJE DOTYCZĄCE ŚRODOWISKA



Przekreślony symbol pojemnika na śmieci oznacza, że tego produktu nie należy wyrzucać razem z normalnymi odpadami domowymi. Sprzęt elektroniczny i elektryczny nieobjęty procesem sortowania selektywnego jest potencjalnie niebezpieczny dla środowiska i zdrowia ludzi ze względu na obecność substancji niebezpiecznych. Prosimy o odpowiedzialną utylizację w autoryzowanych punktach zbiórki odpadów lub recyklingu.

## DEKLARACJA ZGODNOŚCI UE

[http://imagebank.schou.com/MediaLibrary?search=82066\\_DOC](http://imagebank.schou.com/MediaLibrary?search=82066_DOC)



## PUNKT SERWISOWY

Uwaga: Zadając pytania dotyczące niniejszego produktu, należy podawać numer modelu.

Numer modelu można znaleźć na okładce niniejszej instrukcji obsługi i tabliczce znamionowej.

[www.schou.com](http://www.schou.com)

Wyprodukowano w  
Chińskiej Republice  
Ludowej

Producent:

Schou Company A/S  
Nordager 31  
DK-6000 Kolding

Wszelkie prawa zastrzeżone. Niniejszego podręcznika użytkownika nie wolno w żaden sposób powielać częściowo ani w całości, elektronicznie bądź mechanicznie (np. poprzez fotokopie lub skany), tłumaczyć ani przechowywać w bazie danych z funkcją wyszukiwania bez uprzedniej zgody Schou Company A/S wyrażonej na piśmie.

# Herní židle s LED podsvícením

## ÚVOD

Abyste svůj nový elektrický radiátor využili co nejlépe, přečtěte si před použitím tento návod. Doporučujeme také uložit si návod pro případ, že jej budete později potřebovat.

## TECHNICKÉ ÚDAJE

Rozměry: 63x51x116-126 cm

Nastavitelná výška sedáku: 42,5-52,5 cm

Nastavitelný sklon opěradla: 90°-135°

S RGB LED světlem

Zdroj napájení: USB A kabel 5 V 2 A

Délka kabelu: 160 cm

S RF dálkovým ovládáním, včetně baterie CR2025

Frekvence vysílání: 433,92 MHz

Přenosový výkon: -15,1 dBm

Max. RF výstupní výkon (e.i.r.p): 2,19 dBm

Max. hmotnost uživatele: 110 kg

### Použití RGB LED světla

Připojte kabel USB ke zdroji napájení USB A. Dálkovým ovládáním vyberte funkci LED a upravte nastavení.



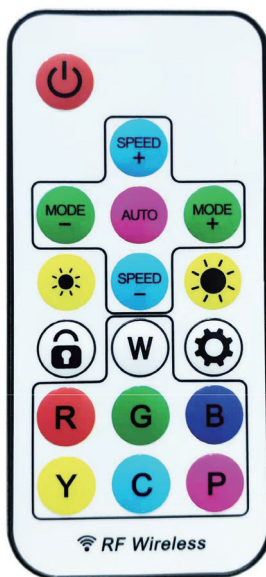











## DÁLKOVÉ OVLÁDÁNÍ



Výrobek třídy III: Určeno pro napájení z odděleného zdroje velmi nízkého napětí (SELV). Napětí zdroje SELV je natolik nízké, že se s ním člověk může běžně dostat do kontaktu bez rizika úrazu elektrickým proudem.



## FUNKCE DÁLKOVÉHO OVLÁDÁNÍ

Tlačítko	Funkce
	Zapnout/vypnout
	Nastavení rychlosti změny barvy LED
	Pomocí tlačítek nastavení režimu -/+ zvolte režim LED (na výběr je několik režimů)
	Nastavení jasu LED světla
	<p>Stiskněte jednou pro automatické přehrávání více efektů. Dlouhým stisknutím po dobu 5 sekund vstoupíte do efektu RGB střídání barev a spustíte test LED pásků.</p> <p>Jeden cyklus: V režimu automatického přehrávání stiskněte jednou tlačítko „SET“, poté stiskněte tlačítko „lock“ pro zachycení aktuální efektové smyčky. Chcete-li zrušit „uzamknutí“ vybraného režimu, stiskněte tlačítko „auto“ nebo tlačítko „mode“.</p>
	Nastavení počtu pixelů LED a pořadí RGB: Dlouhým stisknutím po dobu 5 sekund vstupte do nabídky nastavení a stisknutím tlačítek „MODE +“ a „MODE -“ nastavte počet pixelů LED. Každým stisknutím provedete úpravu o 32 bodů. Stisknutím tlačítka „SET“ uložte nastavení.
	Spárování ID dálkového ovládání: Dlouhým stisknutím po dobu 5 sekund spárujete dálkové ovládání se židlí. (LED pásek třikrát zabliká zeleně), opětovným dlouhým stisknutím po dobu 5 sekund zrušíte spárování (LED pásek třikrát zabliká bíle)
	Jednobarevný režim bílého nepřerušovaného světla
	Jednobarevný režim červeného nepřerušovaného světla
	Jednobarevný režim zeleného nepřerušovaného světla
	Jednobarevný režim modrého nepřerušovaného světla
	Jednobarevný režim žlutého nepřerušovaného světla
	Jednobarevný režim tyrkysového nepřerušovaného světla
	Jednobarevný režim fialového nepřerušovaného světla

CZ

## SOUČÁSTI

a	Opěrka zad
b	Sedák
c	Mechanismus
e	Opěrka hlavy
g	Kolečko x 5
h	Zadní tyč
i	Područka x 2
j	Základna
k	Bederní polštář
l	Plynový píst
m	Šroub x 3
o	Klíč
p	Kabel USB A
t	Koncový uzávěr x 4
w	Koncový uzávěr x 2
x	Šroub x 4
z	Šroub x 4

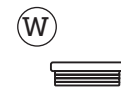
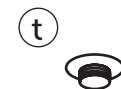
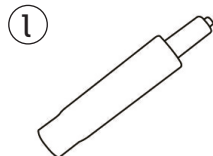
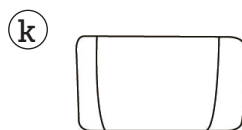
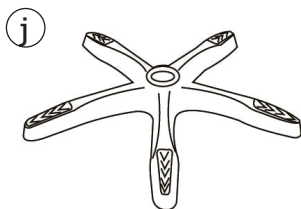
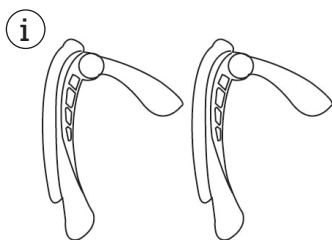
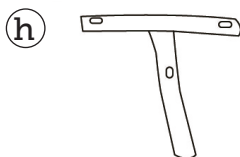
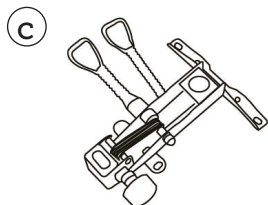
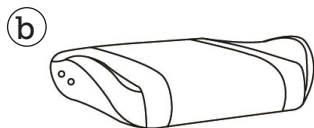
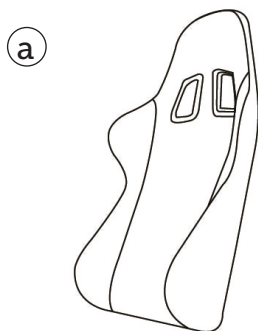

# MONTÁŽ

1

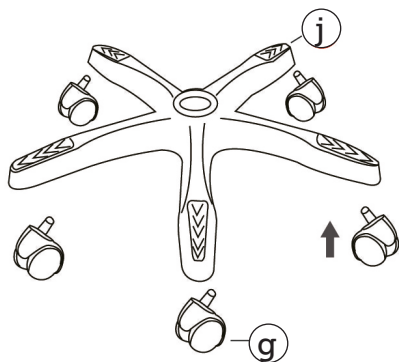

2

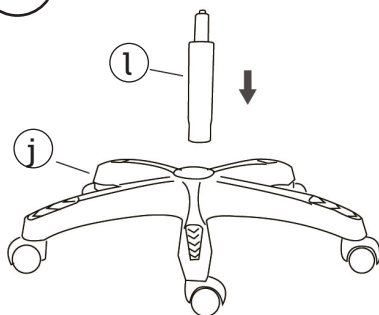

CZ

3

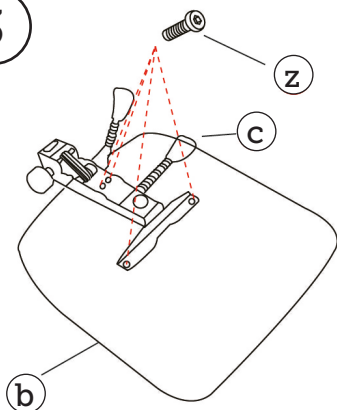

4

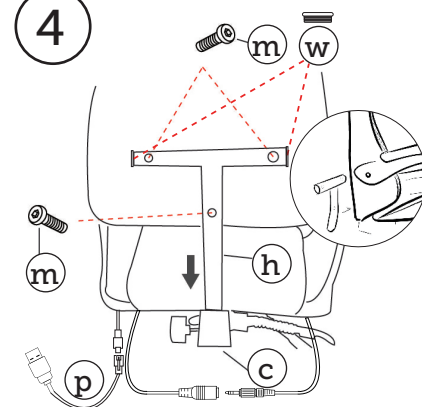

5

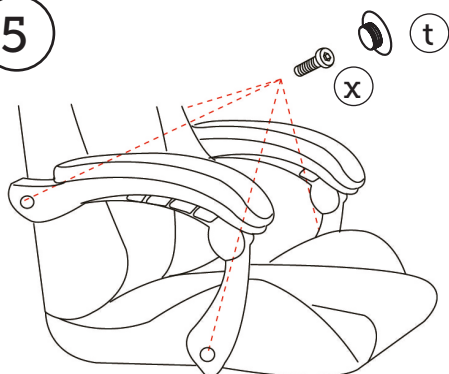

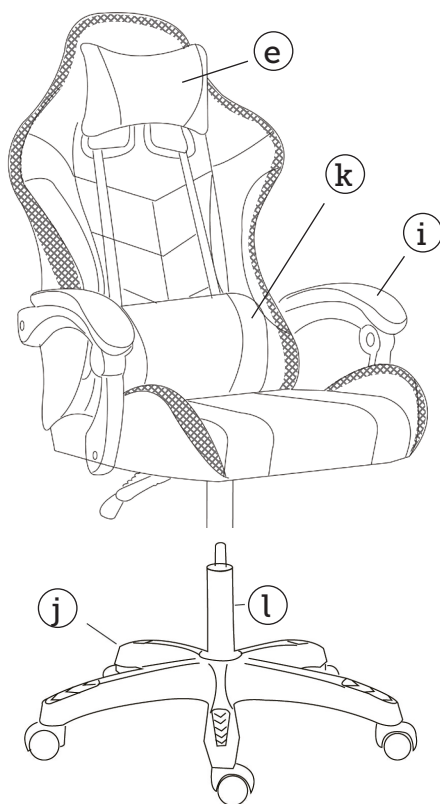

## **ČIŠTĚNÍ A ÚDRŽBA**

Čistěte důkladně vyždímaným hadříkem.

Varování: Výrobek je vyroben z PU kůže a nesmí se ošetřovat prostředky na ošetřování kůže, protože by došlo k poškození PU kůže.

## INFORMACE PRO OCHRANU ŽIVOTNÍHO PROSTŘEDÍ



Symbol přeškrtnuté popelnice s kolečky znamená, že tento výrobek nesmí být likvidován společně s běžným domovním odpadem. Elektronická a elektrická zařízení, která nejsou zahrnuta do procesu selektivního třídění, jsou potenciálně nebezpečná pro životní prostředí a lidské zdraví z důvodu přítomnosti nebezpečných látek. Zajistěte jejich řádnou likvidaci ve schválených zařízeních na likvidaci nebo recyklaci odpadu.

CZ

## EU PROHLÁŠENÍ O SHODĚ

[http://imagebank.schou.com/MediaLibrary?search=82066\\_DOC](http://imagebank.schou.com/MediaLibrary?search=82066_DOC)



---

## SERVISNÍ STŘEDISKO

Poznámka: Při vyřizování všech dotazů uveďte číslo modelu výrobku. Číslo modelu je uvedeno na přední straně této příručky a na registračním štítku výrobku.

[www.schou.com](http://www.schou.com)

---

Vyrobeno v Číně

Výrobce:

Schou Company A/S  
Nordager 31  
DK-6000 Kolding

Všechna práva vyhrazena. Obsah tohoto návodu nesmí být reprodukován, jako celek nebo jeho část, žádným způsobem, elektronicky ani mechanicky, např. fotokopii nebo zveřejněním, přeložen nebo uložen v jakémkoliv systému ukládání a získávání informací bez písemného souhlasu společnosti Schou Company A/S.

---

# Poltrona da gaming con LED

## INTRODUZIONE

Per ottenere le massime prestazioni dal vostro nuovo prodotto, leggere le istruzioni prima dell'uso. Conservare questo manuale per un eventuale riferimento futuro.

## DATI TECNICI

Dimensioni: 63 x 51 x 116-126 cm

Altezza del sedile regolabile: 42,5-52,5 cm

Inclinazione dello schienale regolabile:  
90°-135°

Con luce a LED RGB

Alimentazione: cavo USB tipo A, 5 V, 2 A

Lunghezza del cavo: 160 cm

Con telecomando RF (batteria CR2025)

Frequenza di trasmissione: 433.92 MHz

Potenza di trasmissione: -15,1 dBm

Max potenza RF in uscita (E.I.R.P.): 2,19 dBm

Peso max dell'utilizzatore: 110 kg

### Utilizzo della luce a LED RGB

Collegare il cavo USB a una porta USB tipo A. Con il telecomando, scegliere la funzione dei LED e regolare le impostazioni.







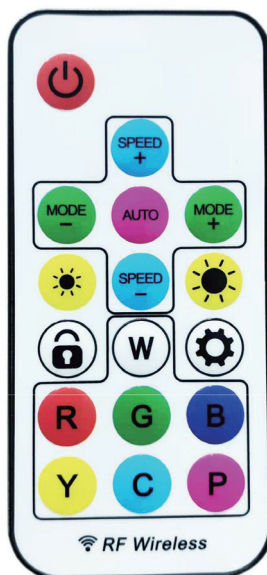











Prodotto di classe III: progettato per essere alimentato da una fonte di alimentazione separata a bassissima tensione di sicurezza (SELV). La tensione di una fonte di alimentazione SELV è sufficientemente bassa da non provocare, normalmente, scariche elettriche alle persone in caso di contatto.

## TELECOMANDO



## FUNZIONI DEL TELECOMANDO

Pulsante	Funzione
	Accensione/spengimento
 , 	Regolazione della velocità di variazione del colore dei LED
 , 	I pulsanti della modalità (-/+) consentono di scegliere la modalità dei LED; è possibile scegliere tra più modalità
 , 	Regolazione della luminosità dei LED
	<p>Premere una volta per riprodurre automaticamente diversi tipi di effetti luminosi. Tenere premuto per 5 secondi per avviare l'effetto di commutazione dei colori RGB e avviare il test della striscia a LED.</p> <p>Ciclo singolo: in modalità di riproduzione automatica, premere una volta il pulsante "SET", quindi premere il pulsante con il lucchetto per selezionare l'effetto in loop attuale. Per "sbloccare" la modalità selezionata, premere il pulsante "AUTO" o il pulsante "MODE".</p>
	Per regolare il numero dei singoli LED e l'ordine dei colori RGB: tenere premuto per 5 secondi per accedere al menu delle impostazioni, quindi premere "MODE +" e "MODE -" per regolare il numero dei singoli LED. Si possono regolare 32 LED ogni volta. Premere "SET" per salvare le impostazioni.
	Abbinamento del telecomando: tenere premuto per 5 secondi per abbinare il telecomando alla poltrona (la striscia di LED lampeggia 3 volte in verde); tenere premuto nuovamente per 5 secondi per annullare l'abbinamento (la striscia a LED lampeggia 3 volte in bianco).
	Modalità monocromatica: bianco fisso
	Modalità monocromatica: rosso fisso
	Modalità monocromatica: verde fisso
	Modalità monocromatica: blu fisso
	Modalità monocromatica: giallo fisso
	Modalità monocromatica: azzurro fisso
	Modalità monocromatica: viola fisso

## COMPONENTI

a	Schienale
b	Seduta
c	Meccanismo
e	Poggiatesta
g	Rotella x 5
h	Barra posteriore
i	Bracciolo x 2
j	Base
k	Cuscino lombare
l	Cilindro ad aria
m	Bullone x 3
o	Chiave
p	Cavo USB tipo A
t	Tappo x 4
w	Tappo x 2
x	Bullone x 4
z	Bullone x 4

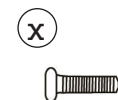
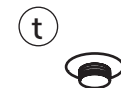
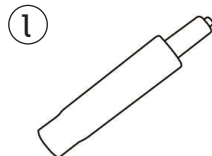
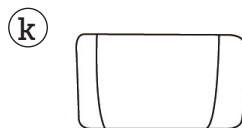
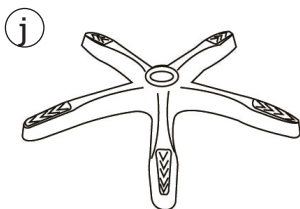
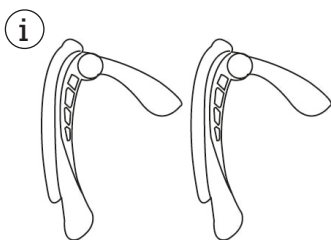
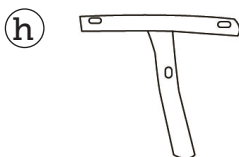
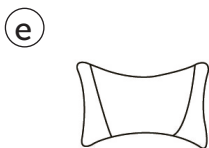
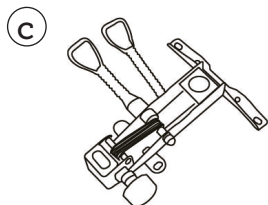
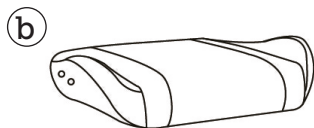
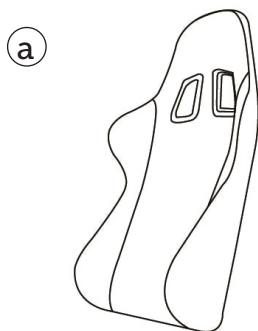



# MONTAGGIO

1

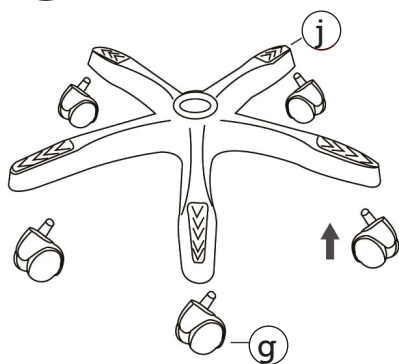

2

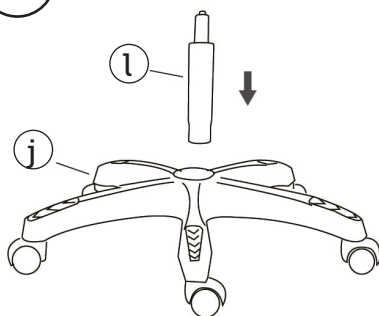

3

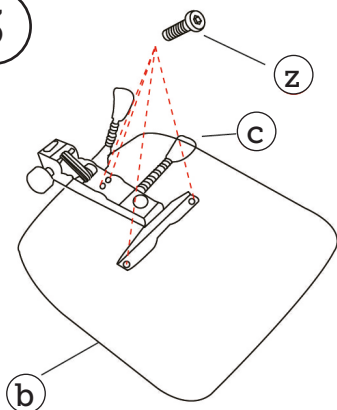

4

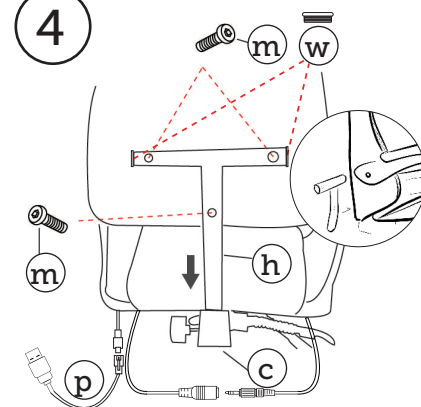

5

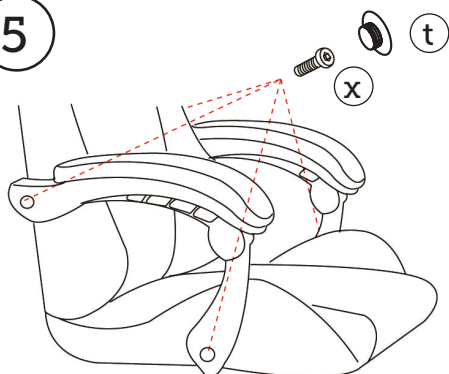

IT

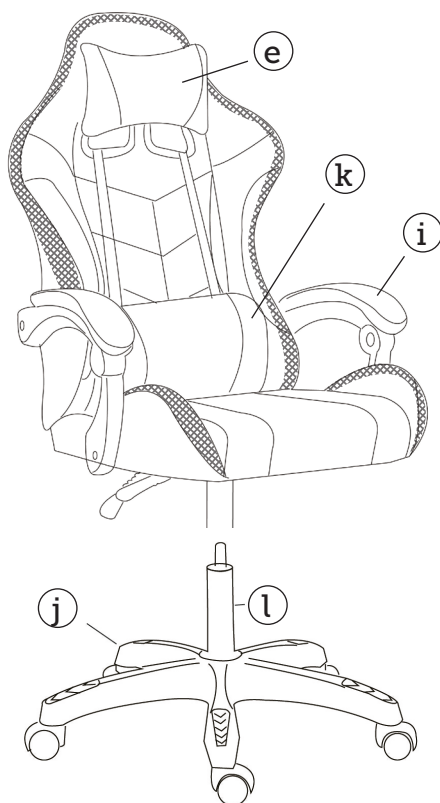

### **PULIZIA E MANUTENZIONE**

Pulire con un panno umido ben strizzato.

Avvertenza: questo prodotto è realizzato in pelle PU e non deve essere trattato con prodotti per la cura della pelle normale, poiché danneggiano la pelle PU.

## INFORMAZIONI AMBIENTALI



Il simbolo del bidone barrato indica che questo prodotto non deve essere smaltito con i normali rifiuti domestici. Le apparecchiature elettroniche ed elettriche smaltite in modo errato sono potenzialmente pericolose per l'ambiente e la salute umana, a causa della presenza di sostanze pericolose. Smaltire il prodotto in modo responsabile presso un impianto di smaltimento o riciclo autorizzato.

## DICHIARAZIONE DI CONFORMITÀ UE

[http://imagebank.schou.com/MediaLibrary?search=82066\\_DOC](http://imagebank.schou.com/MediaLibrary?search=82066_DOC)



---

## CENTRO ASSISTENZA

Nota: indicare il numero di modello del prodotto in ogni richiesta di assistenza.

Il numero di modello è riportato sulla copertina di questo manuale e sulla targhetta del prodotto.

[www.schou.com](http://www.schou.com)

---

Fabbricato in P.R.C.

Produttore:

Schou Company A/S  
Nordager 31  
DK-6000 Kolding

---

Tutti i diritti riservati. I contenuti di questo manuale non possono essere riprodotti in parte o per intero, elettronicamente o meccanicamente (ad es. mediante fotocopie o scansioni), tradotti o archiviati in sistemi di memorizzazione e recupero di informazioni senza il consenso scritto di Schou Company A/S.

---

# Herná stolička s LED

## ÚVOD

Na dosiahnutie maximálnych výsledkov z vášho nového elektrického radiátora si pred použitím prečítajte tieto pokyny. Rovnako vám odporúčame, aby ste si pokyny odložili pre prípad, že by ste ich mohli potrebovať neskôr.

## TECHNICKÉ ÚDAJE

Veľkosť: 63 x 51 x 116 – 126 cm

Nastaviteľná výška sedadla:  
42,5 – 52,5 cm

Nastaviteľný uhol chrbtovej opierky:  
90° – 135°

S RGB LED osvetlením

Napájanie: Kábel USB A 5 V, 2 A

Dĺžka kábla: 160 cm

S RF diaľkovým ovládaním vrátane batérie CR2025

Vysielacia frekvencia: 433,92 MHz

Prenosový výkon: -15,1 dBm

Max. výstupný výkon RF (e.i.r.p): 2,19 dBm

Max. hmotnosť používateľa: 110 kg

### Použitie RGB LED osvetlenia

Pripojte kábel USB k napájaciemu zdroju USB A. Pomocou diaľkového ovládania vyberte funkciu LED a upravte nastavenia.









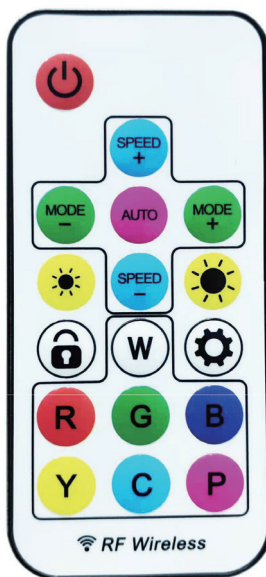









Výrobok triedy III: Navrhnutý na napájanie z oddeleného zdroja veľmi nízkeho napätia (SELV).

Napätie zdroja SELV je dostatočne nízke na to, aby s ním človek mohol prísť do kontaktu bez rizika úrazu elektrickým prúdom.

## DIAĽKOVÝ OVLÁDAČ



## FUNKCIE DIAĽKOVÉHO OVLÁDANIA

Tlačidlo	Funkcia
	Zapnutie/vypnutie napájania
 , 	Nastavenie rýchlosti zmeny farby LED
 , 	Pomocou tlačidiel režimov -/+ vyberte režim LED (na výber je viacero režimov)
 , 	Nastavenie jasů LED svetiel
	Jedným stlačením tlačidla automaticky spustíte rôzne typy efektov. Dlhým stlačením v trvaní 5 sekúnd vstúpite do efektu farebného skoku RGB a spustíte test pásov LED.  Jeden cyklus: V režime automatického prehrávania stlačte raz tlačidlo „SET“ (NASTAVIŤ) a potom stlačením tlačidla „lock“ (zamknúť) zachováte aktuálnu efektovú slučku. Ak chcete „odblokovať“ zvolený režim, stlačte tlačidlo „auto“ (automaticky) alebo tlačidlo „mode“ (režim).
	Nastavenie počtu pixlových bodov LED a poradia RGB: Dlhým stlačením v trvaní 5 sekúnd vstúpite do ponuky nastavenia a stlačením tlačidiel „MODE +“ (REŽIM +) a „MODE -“ (REŽIM -) nastavte počet pixlových bodov LED. Zakaždým sa upraví 32 bodov. Stlačením tlačidla „SET“ (NASTAVIŤ) uložíte nastavenia.
	Priradenie ID diaľkového ovládania: Dlhým stlačením v trvaní 5 sekúnd priradíte diaľkový ovládač k stoličke. (Pás LED 3-krát zabliká nazeleno), opätovným dlhým stlačením na 5 sekúnd zrušíte priradenie (Pás LED 3-krát zabliká nabielo)
	Biely statický monochromatický režim
	Červený statický monochromatický režim
	Zelený statický monochromatický režim
	Modrý statický monochromatický režim
	Žltý statický monochromatický režim
	Azórový statický monochromatický režim
	Fialový statický monochromatický režim

SK

## DIELY

a	Spät
b	Sedadlo
c	Mechanizmus
e	Opierka hlavy
g	Koliesko x 5
h	Zadný panel
i	Opierka na ruku x 2
j	Základňa
k	Bedrová poduška
l	Plynový zdvihadí mechanismus
m	Skrutka x 3
o	Kľúč
p	Kábel USB A
t	Koncový uzáver x 4
w	Koncový uzáver x 2
x	Skrutka x 4
z	Skrutka x 4

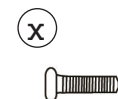
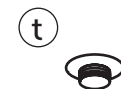
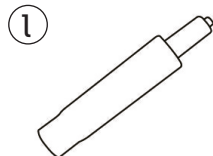
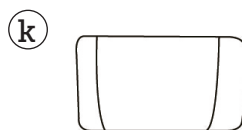
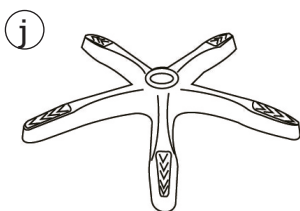
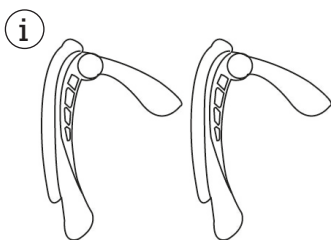
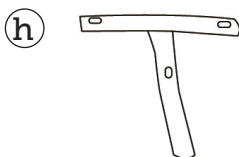
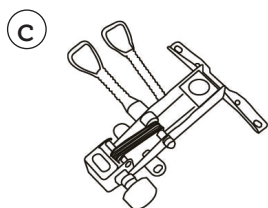
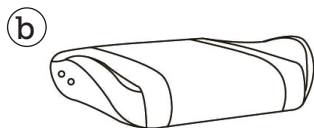
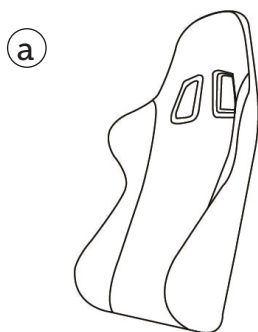

# MONTÁŽ

1

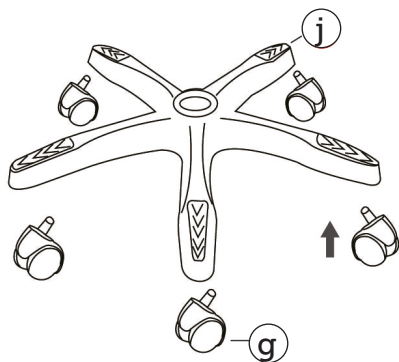

2

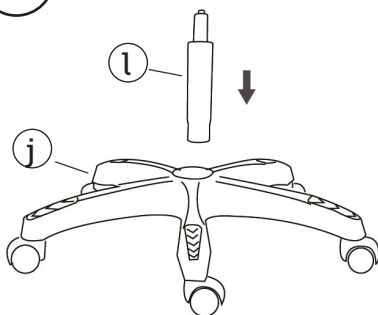

3

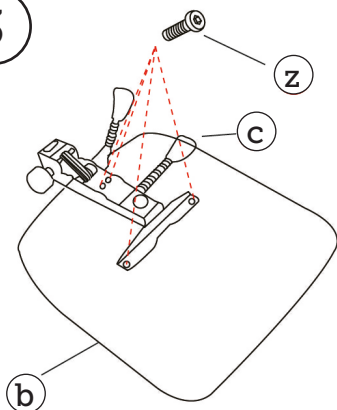

4

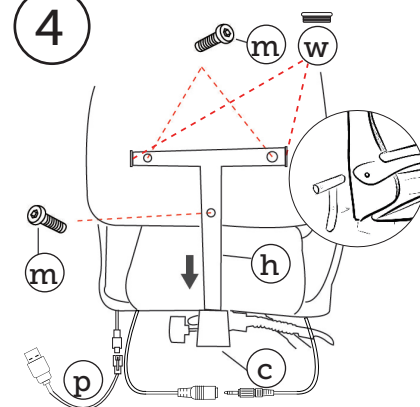

SK

5

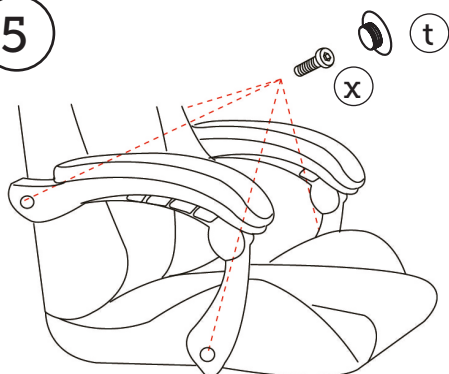

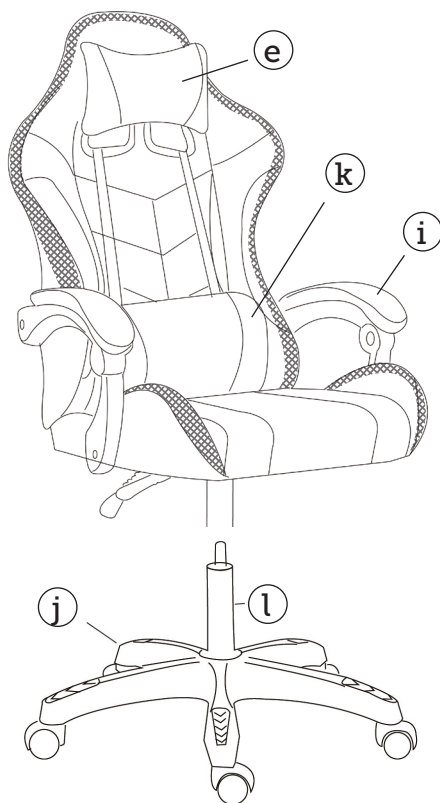

## ČISTENIE A ÚDRŽBA

Čistite vyžmýkanou handričkou.

Varovanie: Tento výrobok je vyrobený z PU kože a nesmie sa ošetrovať prostriedkami na ošetrovanie kože, pretože tieto prostriedky PU kožu poškodia.



## INFORMÁCIE TÝKAJÚCE SA ŽIVOTNÉHO PROSTREDIA



Symbol preškrtnutého odpadkového koša znamená, že tento výrobok sa nesmie likvidovať cestou bežného domového odpadu. Elektronické a elektrické zariadenia, ktoré nie sú zahrnuté do procesu selektívneho triedenia, sú potenciálne nebezpečné pre životné prostredie a ľudské zdravie z dôvodu prítomnosti nebezpečných látok. Výrobok zodpovedne zlikvidujte v schválenom zariadení na spracovanie odpadu alebo recykláciu.

SK

## VYHLÁSENIE O ZHODE EÚ

[http://imagebank.schou.com/MediaLibrary?search=82066\\_DOC](http://imagebank.schou.com/MediaLibrary?search=82066_DOC)



## SERVISNÉ STREDISKO

Poznámka: Uvedte číslo modelu produktu v súvislosti so všetkými dotazmi. Číslo modelu je uvedené na prednej strane tejto príručky a na registračnom štítku výrobku.

[www.schou.com](http://www.schou.com)

Vyrobené v ČĽR

Výrobca:

Schou Company A/S  
Nordager 31  
DK-6000 Kolding

Všetky práva vyhradené. Obsah tejto príručky sa nesmie ako celok ani čiastočne žiadnym spôsobom, elektronickým alebo mechanickým, reprodukovať, napríklad kopírovaním alebo publikovaním, prekladaním alebo uložením do systému na ukladanie a vyhľadávanie informácií, bez písomného súhlasu spoločnosti Schou Company A/S.

# Silla para gamers con LED

## INTRODUCCIÓN

Para sacar el máximo provecho a su nuevo producto, lea este manual de instrucciones antes de usarlo. Por favor, guarde este manual en caso de que necesite consultarlo en un momento posterior.

## DATOS TÉCNICOS

Tamaño: 63 × 51 × 116 - 126 cm

Altura del asiento regulable:  
42,5-52,5 cm

Ángulo de respaldo ajustable: 90°-135°

Con luces LED RGB

Alimentación: Cable USB A 5 V 2 A

Longitud del cable: 160 cm

Con mando a distancia por RF y pila  
CR2025 incluida

Frecuencia de transmisión: 433,92 Mhz

Potencia de transmisión: -15,1 dBm

Potencia máx. de salida de RF (E.I.R.P.):  
2,19 dBm

Peso máx. del usuario: 110 kg

### Uso de las luces LED RGB

Conecte el cable USB a una fuente de alimentación USB A. Utilice el mando a distancia para elegir la función LED y ajustar la configuración.







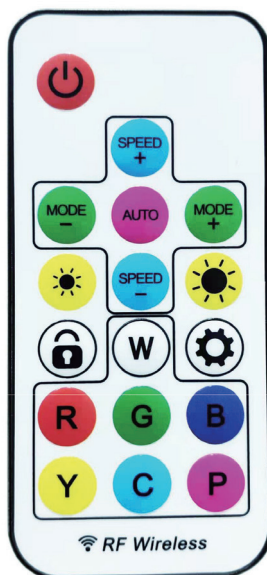











Producto de clase III: Diseñado para recibir energía de una fuente de alimentación independiente de tensión extrabaja de seguridad (SELV). La tensión de un circuito SELV es lo suficientemente baja como para que una persona pueda entrar en contacto con él sin riesgo de sufrir una descarga eléctrica.

## MANDO A DISTANCIA



## FUNCIONES DEL MANDO A DISTANCIA

Botón	Función
	Encendido/apagado.
 , 	Permite ajustar la velocidad del cambio de color de las luces LED.
 , 	Utilice los botones de modo -/+ para elegir el modo de LED (varios modos entre los que elegir).
 , 	Permite ajustar el brillo de las luces LED.
	Al pulsarlo una vez, se reproducen automáticamente varios tipos de efectos. Al mantenerlo pulsado 5 segundos, se activa el efecto de salto de color RGB y se inicia la tira reactiva de luces LED.  Ciclo único: en el modo de reproducción automática, pulse el botón "SET" una vez y, a continuación, pulse el botón del candado para fijar la secuencia de efectos actual. Para desbloquear el modo seleccionado, pulse el botón "AUTO" o el botón "MODE".
	Para ajustar el número de puntos de píxel del LED y el orden de RGB: manténgalo pulsado 5 segundos para entrar en el menú de configuración y pulse "MODE +" y "MODE -" para ajustar el número de puntos de píxel del LED. Ajusta 32 puntos cada vez. Pulse el botón "SET" para guardar los ajustes.
	Coincidencia de identificación del mando a distancia: Manténgalo pulsado 5 segundos para emparejar el mando a distancia con la silla (la tira de luces LED parpadeará en verde 3 veces), púlselo de nuevo durante 5 segundos para anular la coincidencia (la tira de luces LED parpadeará en blanco 3 veces).
	Modo monocromo estático blanco
	Modo monocromo estático rojo
	Modo monocromo estático verde
	Modo monocromo estático azul
	Modo monocromo estático amarillo
	Modo monocromo estático cian
	Modo monocromo estático morado

ES

## PIEZAS

a	Respaldo
b	Asiento
c	Mecanismo
e	Reposacabezas
g	Ruedas × 5
h	Barra trasera
i	Reposabrazos × 2
j	Base
k	Soporte lumbar
l	Muelle de gas
m	Perno × 3
o	Llave
p	Cable USB A
t	Tapón × 4
w	Tapón × 2
x	Perno × 4
z	Perno × 4

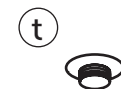
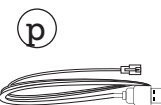
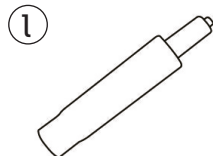
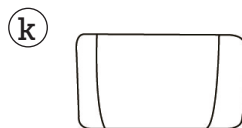
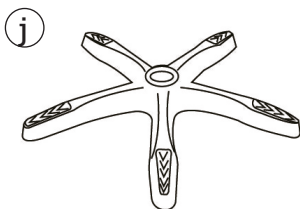
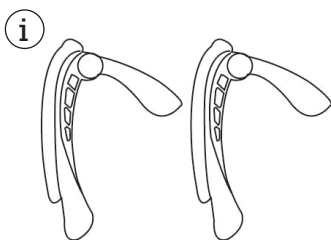
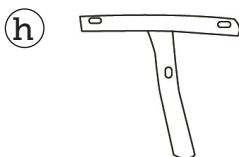
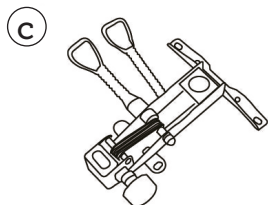
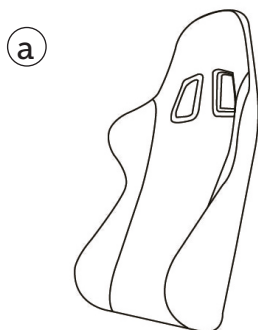

# MONTAJE

1

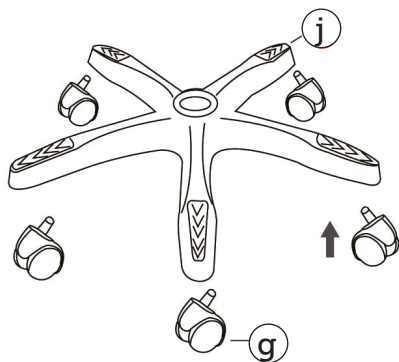

2

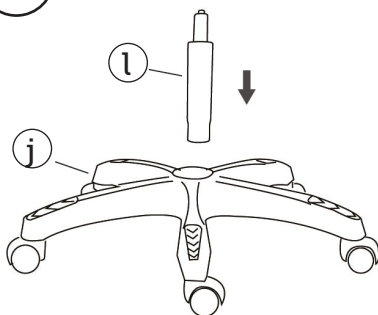

3

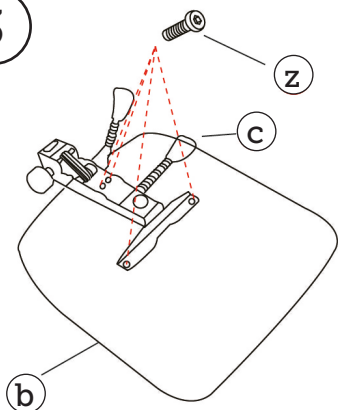

4

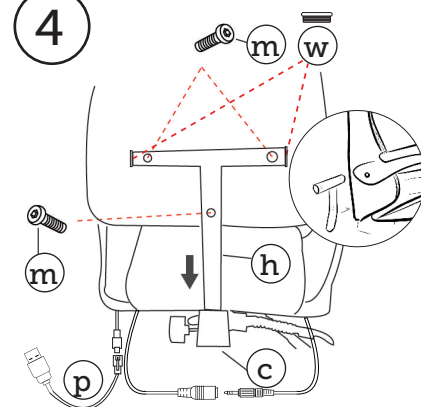

ES

5

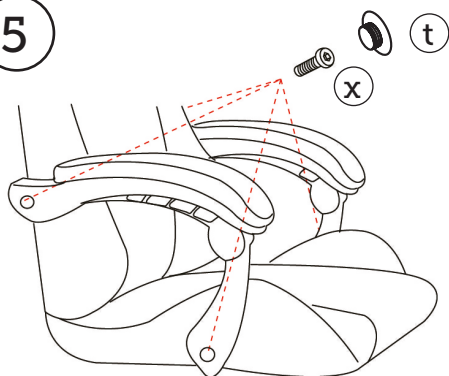

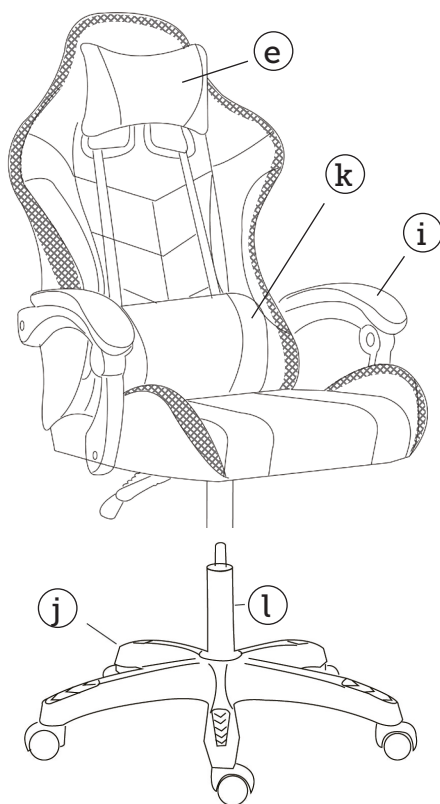

## **LIMPIEZA Y MANTENIMIENTO**

Limpiar con un paño muy escurrido.

Advertencia: este producto está fabricado en cuero de PU y no debe tratarse con productos para el cuidado del cuero, ya que destruirían el material.

## INFORMACIÓN MEDIOAMBIENTAL



El símbolo del contenedor de basura tachado significa que este producto no debe eliminarse con la basura doméstica normal. Los equipos electrónicos y eléctricos no incluidos en el proceso de clasificación selectiva son potencialmente peligrosos para el medio ambiente y la salud debido a la presencia de sustancias peligrosas. Deseche el producto de forma responsable en una instalación de residuos o de reciclaje autorizada.

## DECLARACIÓN UE DE CONFORMIDAD

[http://imagebank.schou.com/MediaLibrary?search=82066\\_DOC](http://imagebank.schou.com/MediaLibrary?search=82066_DOC)



## CENTRO DE SERVICIO

Nota: Por favor, cite el número de modelo del producto relacionado con todas las preguntas.

El número de modelo se muestra en la parte frontal de este manual y en la placa de características del producto.

[www.schou.com](http://www.schou.com)

Fabricado en la R.P.C.

Fabricante:

Schou Company A/S  
Nordager 31  
DK-6000 Kolding

Todos los derechos reservados. El contenido de este manual no puede ser reproducido, ni total ni tampoco parcialmente, de cualquier forma por medios electrónicos o mecánicos, por ejemplo, fotocopias o publicación, traducción o guardado en un almacén de información y sistema de recuperación, sin la previa autorización por escrito de Schou Company A/S.

# Cadeira de gaming com LED

## INTRODUÇÃO

Leia este manual antes de utilizar o seu novo produto para tirar o máximo partido do mesmo.

Conserve o manual, caso necessite de o consultar posteriormente.

## DADOS TÉCNICOS

Tamanho: 63 x 51 x 116–126 cm

Altura do assento ajustável:  
42,5–52,5 cm

Ângulo do encosto ajustável: 90°–135°

Com luz LED RGB

Fonte de alimentação: Cabo USB A de  
5 V, 2 A

Comprimento do cabo: 160 cm

Com comando à distância RF, incluindo  
pilha CR2025

Frequência de transmissão: 433,92 MHz

Potência de transmissão: –15,1 dBm

Potência máxima de saída RF (PIRE):  
2,19 dBm

Peso máx. do utilizador: 110 kg

## Utilização de luz LED RGB

Ligue o cabo USB a uma fonte de alimentação USB A. Utilize o comando à distância para escolher a função LED e ajustar as definições.



Produto de classe III: Concebido para uma alimentação de tensão extra baixa separada (SELV).





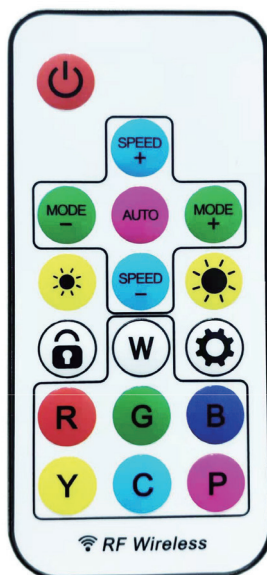











A tensão de uma alimentação SELV é baixa o suficiente para uma pessoa poder entrar em contacto com a mesma normalmente, sem o risco de choque elétrico.

## COMANDO À DISTÂNCIA





## FUNÇÕES DO COMANDO À DISTÂNCIA

Botão	Função
	Ligar/desligar
 , 	Ajuste a velocidade da mudança de cor do LED
 , 	Use os botões de modo -/+ para escolher o modo LED (diversos modos à escolha)
 , 	Ajuste a luminosidade dos LED
	<p>Prima uma vez para reproduzir automaticamente diversos tipos de efeitos. Prima durante 5 segundos para entrar no efeito de salto RGB colorido e iniciar o teste da fita LED.</p> <p>Um único ciclo: No modo de reprodução automática, prima o botão "SET" (Definir) uma vez, depois prima o botão de "bloquear" para capturar o atual ciclo de efeitos. Para "desbloquear" o modo selecionado, prima o botão "auto" ou o botão "mode" (modo).</p>
	Para ajustar o número de pontos de pixel do LED e a ordem de RGB: Prima durante 5 segundos para entrar no menu de configuração e prima "MODE +" (Modo +) e "MODE -" (Modo -) para ajustar o número de pontos de pixel LED. Os pontos são ajustados em grupos de 32 pontos. Prima "SET" (Definir) para guardar as definições.
	Correspondência da ID do comando à distância: Prima durante 5 segundos para fazer corresponder o comando à distância à cadeira. (A fita LED piscará a verde 3 vezes), prima novamente durante 5 segundos para cancelar a correspondência (a fita LED piscará a branco 3 vezes)
	Modo monocromático estático branco
	Modo monocromático estático vermelho
	Modo monocromático estático verde
	Modo monocromático estático azul
	Modo monocromático estático amarelo
	Modo monocromático estático ciano
	Modo monocromático estático púrpura

## PEÇAS

a	Encosto
b	Assento
c	Mecanismo
e	Encosto de cabeça
g	Rodizio x 5
h	Barra traseira
i	Apoio de braço x 2
j	Base
k	Almofada lombar
l	Elevador a gás
m	Parafuso x 3
o	Chave inglesa
p	Cabo USB A
t	Tampa x 4
w	Tampa x 2
x	Parafuso x 4
z	Parafuso x 4

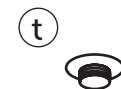
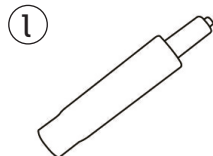
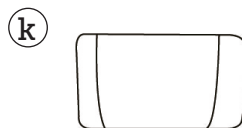
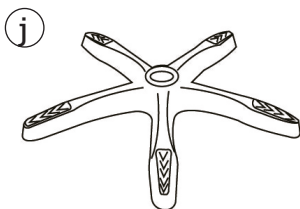
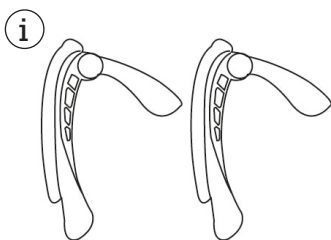
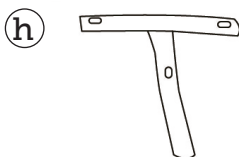
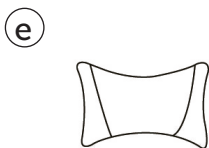
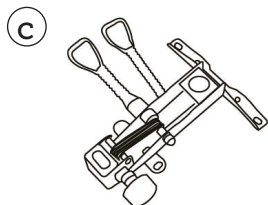
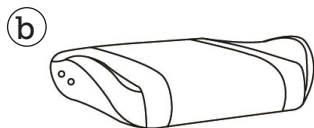
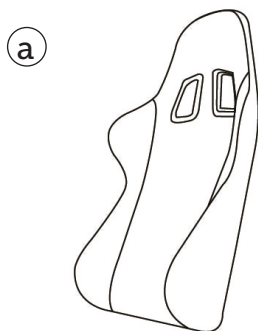

# MONTAGEM

1

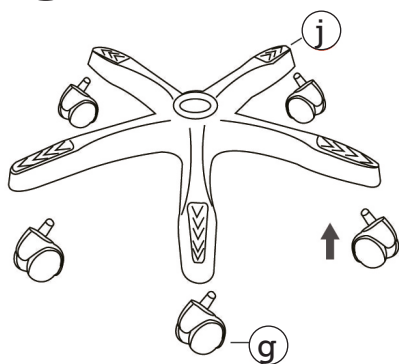

2

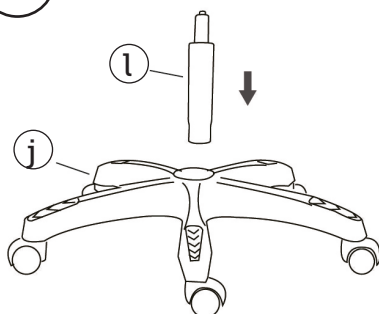

3

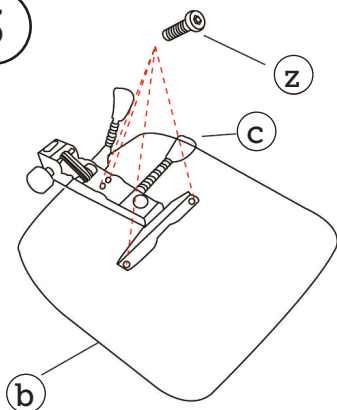

4

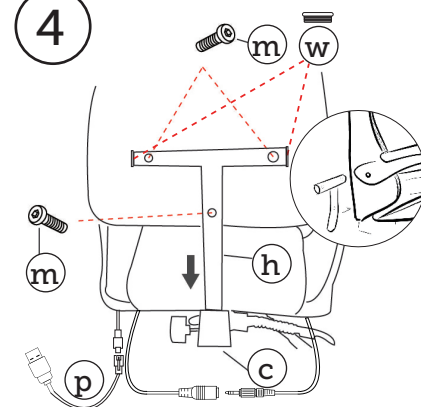

PT

5

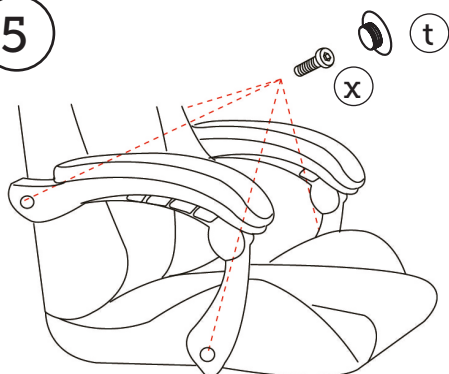

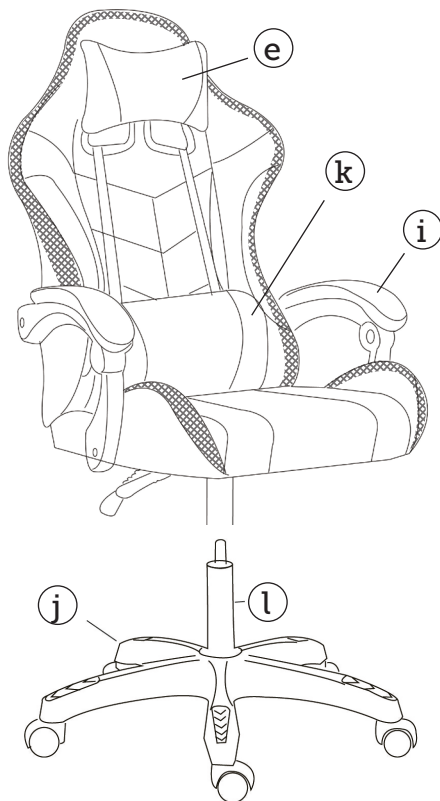

### **LIMPEZA E MANUTENÇÃO**

Limpe com um pano ligeiramente humedecido.

Aviso: Este produto é feito em pele de PU e não deve ser tratado com produtos para tratamento de pele, uma vez que estes destroem a pele de PU.

## INFORMAÇÃO AMBIENTAL



O símbolo do caixote do lixo com uma cruz significa que este produto não deve ser eliminado com o lixo doméstico normal.

Os equipamentos elétricos e eletrônicos não incluídos no processo de triagem seletiva podem ser nocivos para o ambiente e a saúde humana devido à presença de substâncias perigosas. Elimine-os de forma responsável numa instalação de resíduos ou reciclagem aprovada.

PT

## DECLARAÇÃO UE DE CONFORMIDADE

[http://imagebank.schou.com/MediaLibrary?search=82066\\_DOC](http://imagebank.schou.com/MediaLibrary?search=82066_DOC)



---

## CENTRO DE ASSISTÊNCIA

Nota: indique o número do modelo do produto em todas as consultas.

O número do modelo é indicado nas primeiras páginas deste manual e na placa de identificação do produto.

[www.schou.com](http://www.schou.com)

---

Fabricado na RPC

Fabricante:

Schou Company A/S  
Nordager 31  
DK-6000 Kolding

---

Todos os direitos reservados. O conteúdo deste manual não pode ser reproduzido, na totalidade ou em parte, por qualquer meio eletrônico ou mecânico, por exemplo, fotocópia ou publicação, traduzido ou guardado num sistema de armazenamento e recuperação de informações sem a autorização escrita da Schou Company A/S.

---

